

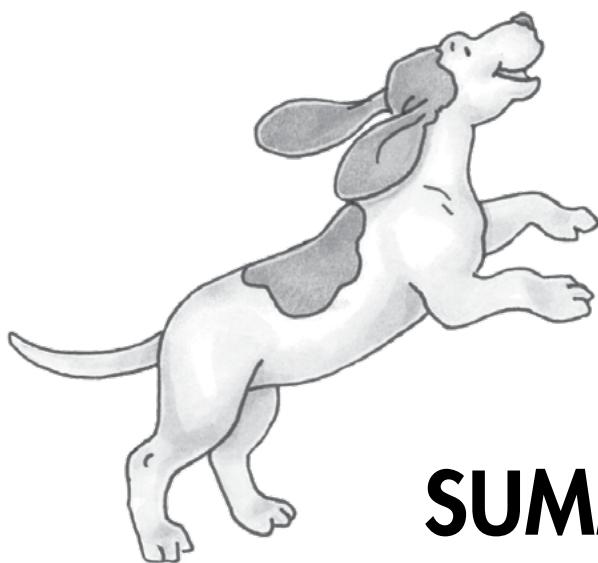

The Superkids[★] Reading Program



SUMMER PACKET

For students who received *Superkids* first-grade instruction in the most recent academic year

SUMMER PACKET

First Grade

Contents

SECTION 1: Decoding & Spelling Practice

Practice Pages 1–10

SECTION 2: Decoding Games

Game Directions

Word Cards

Game Boards & Pieces

SECTION 3: Reader Response

Summer Reading Log

My Book Review

About a Story Character

About an Informational Book

Book Talk Questions

SECTION 4: Superkids Stories

Missing Coconut

The Hide-Out



PRINTING HELP

To print this PDF in any browser, choose “Print” from the “File” menu and use the dialog box to print one or more pages at a time.

Alternatively, you may download this PDF and open and print it using Acrobat Reader DC, a free software application from Adobe. Visit helpx.adobe.com for help printing in Acrobat Reader DC.

SECTION 1: Decoding & Spelling Practice

★ Practice Pages 1–10

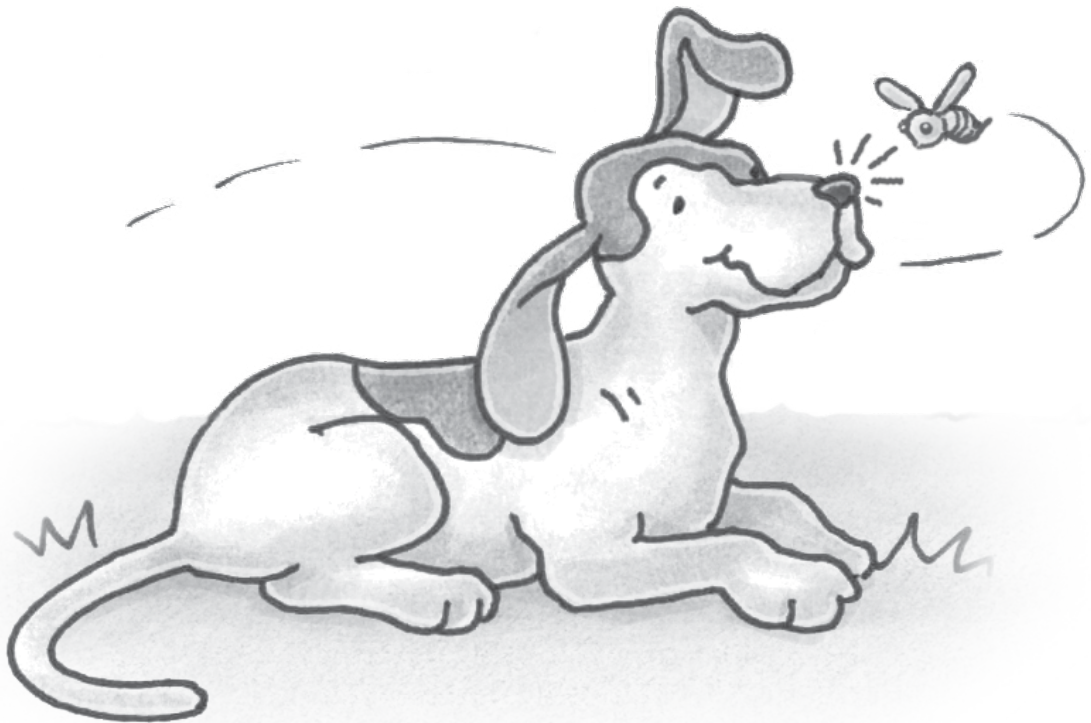

Directions: Have your child complete each word with **oa** or **ai**, and then write a sentence or draw a picture to show its meaning.

1. tr____n	2. s____p
3. t____d	4. sn____l
5. br____d	6. c____t
7. g____l	8. t____l

Directions: Have your child write **ee** to complete the words on stars and **ea** to complete the words on hearts. Then list each word in the correct group for the spelling of **long e**.

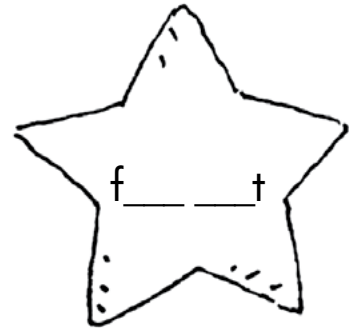
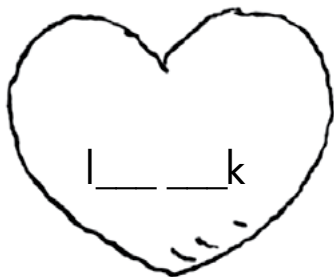
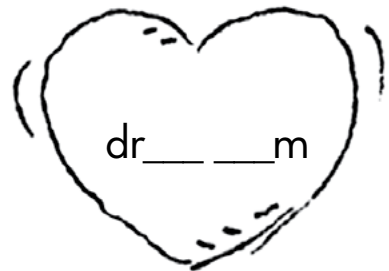
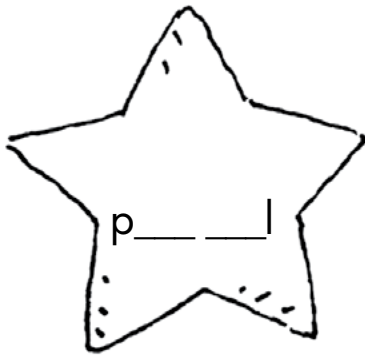
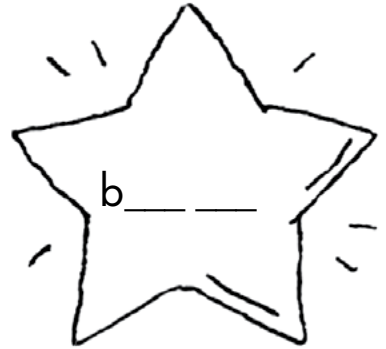
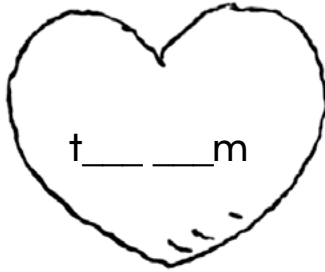
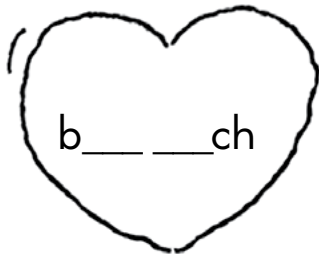

ee

ea

1. _____

5. _____

2. _____

6. _____

3. _____

7. _____

4. _____

8. _____

Directions: Have your child trace the gray letters and write the missing vowel pair to complete a word in each sentence.

oa ee

1. Frits will sw _____ p the steps.

ai oa

3. Tac put on her c _____ t.

oa ee

2. Sal felt sick and his thr _____ t hurt.

ea oa

4. Toc keeps her room cl _____ n.

ai ea

5. Oswald likes to p _____ nt.

ue ie

6. The sun shone in the bl _____ sky.

ai ie

7. Each team had 3 goals, so the game was a t _____.



Directions: Have your child complete each word with **oi** or **oy**, and then write a sentence or draw a picture to show its meaning.

1. c____n	2. b_____
3. t_____	4. _____l
5. b_____l	6. enj_____
7. j_____n	8. p_____nt

Directions: Have your child write **ow** to complete the words, and then list each word in the correct group for the vowel sound.

A Snow Shower

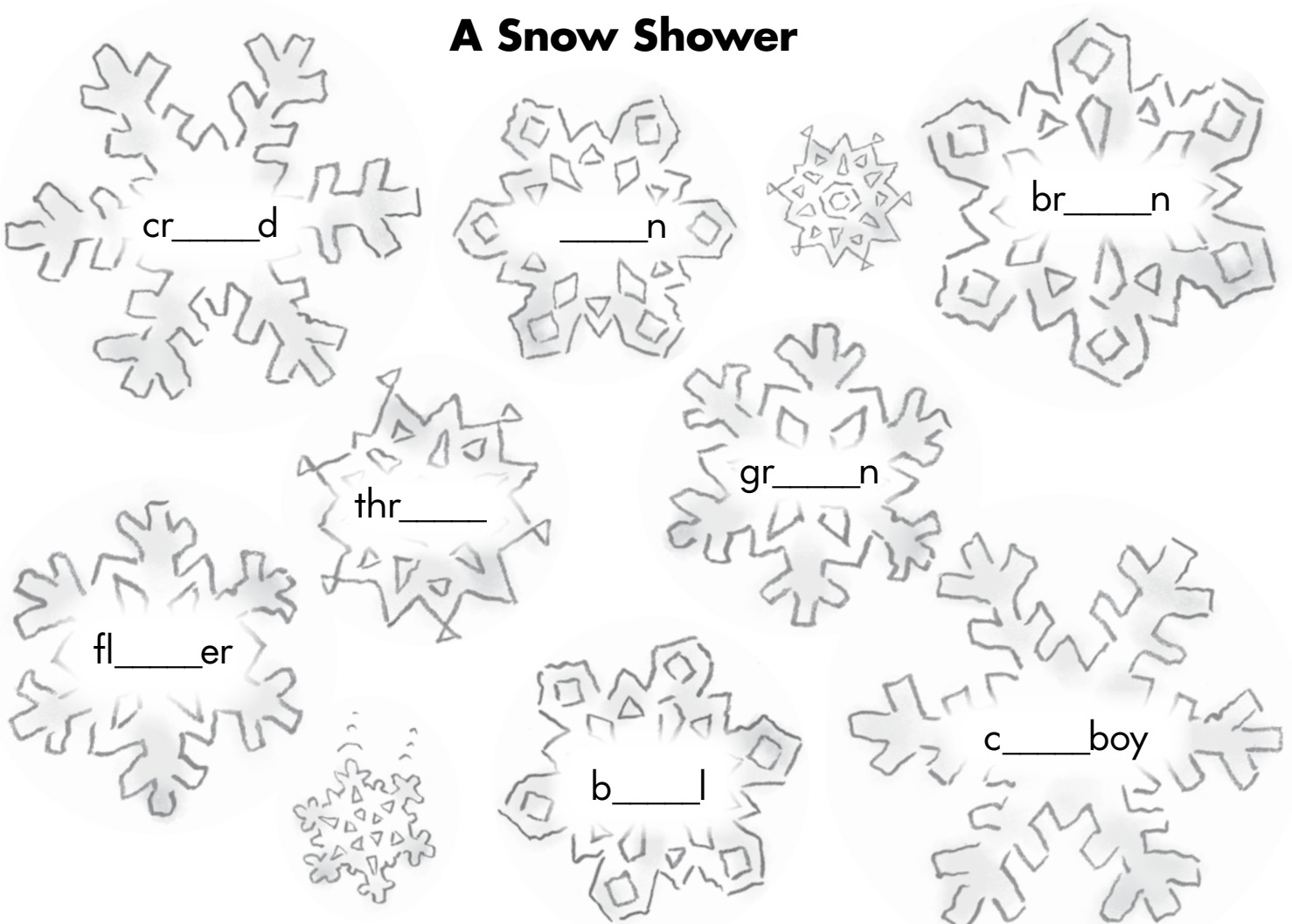

ow = owl

1. _____
2. _____
3. _____
4. _____

ow = snow

5. _____
6. _____
7. _____
8. _____

Directions: Have your child complete each word with **ar** or **or**, and then write a sentence or draw a picture to show its meaning.

1. c_____

2. h_____n

3. c_____n

4. y_____n

5. sh_____k

6. st_____m

7. f_____est

8. j_____

Directions: Have your child find and circle the words that have the sound **er**, and then list them in the correct group for their spellings.

A Perfect Party

dinner



ladder



turn

under

girl



shirt



fur

frog

bird



curb

dress

rise



ir

er

ur

1. _____

4. _____

7. _____

2. _____

5. _____

8. _____

3. _____

6. _____

9. _____

Directions: Have your child complete each sentence using a word from the box.

scarf	sports	turn	bird
pepper	thirsty	hurt	farm

1. Eating pretzels made Doc _____.

2. Ettabetta had a _____ around her neck.

3. Sal fell and got _____.



4. Our pet _____ chirps a lot in the morning.

5. Toc's uncle has a big barn on his _____.

6. It was Icky's _____ to wash the dishes.

7. Tic likes to play lots of _____.

8. The _____ made Cass sneeze.



Directions: Have your child list the words with the short **oo** sound under the word **good** and the words with the long **oo** sound under the word **scoop** at the bottom of the page.

Good Scoops



good

scoop

1. _____

5. _____

2. _____

6. _____

3. _____

7. _____

4. _____

8. _____

Directions: Have your child complete each sentence using a word from the box.

foot
cook

tooth
book

pool
broom

boots
woods

1. Toc had a wiggly _____.



2. Golly hurt his _____.

3. Alf used a _____ to sweep the porch.

4. Oswald was reading a good _____.



5. Rain _____ keep your feet from getting wet.

6. The kids like to swim at the _____.

7. Tic helps _____ dinner.



8. Frits's grandpop has a cabin in the _____.

SECTION 2: Decoding Games

- ★ Game Directions
- ★ Word Cards
- ★ Game Boards & Pieces



Directions: Use the word cards and game boards on the next pages to play fun decoding games with your child! See the directions below for six different games.

Concentration

Materials: Two copies of at least one page of Word Cards

Preparation: Cut out the cards and mix them up. Spread out the cards with words facedown.

To Play: Two players take turns turning over two cards and reading aloud the words. If the words match, the player should use the word in a sentence and then keep the cards. If the words don't match, the cards should be turned facedown again in their original places. Play continues until all the cards are matched. The player with the most cards at the end wins.

Slapjack

Materials: Two copies of at least two pages of Word Cards

Preparation: Cut out the cards to make two matching sets of cards, one for each player. Players place their cards in a stack in front of them.

To Play: Both players turn over a card from their own set at the same time. If the cards show different words, they turn over a new card. If the same word is shown on both cards, each player slaps a hand on top of the cards and says the word. The first player to do this uses the word in a sentence and keeps the pair of cards. (If you don't want to slap cards, the first player to say the word keeps the cards.) Play continues until all cards are matched. The player with the most cards at the end wins.

Roll and Rhyme

Materials: At least two pages of Word Cards, a die, paper, and a pencil

Preparation: Cut out the cards and place them facedown in a stack. Write each player's name at the top of separate columns on a sheet of paper.

To Play: One player turns over a card, reads the word, and rolls the die. Based on the number rolled on the die, the player must name or write 1–6 words that rhyme with and have the same ending letters as the word on the card. The player receives one point for each rhyming word. Then the next player takes a turn. Play continues until all the cards have been used. Player with the highest score wins.

Road Trip

Materials: At least two pages of Word Cards, a die, and a car cut out from the Game Pieces page or a small toy car for each player

Preparation: Cut out the Word Cards and line them faceup in a long winding path.

To Play: Players take turns rolling the die and driving their car past that number of cards while reading aloud each word. (If children have trouble counting and reading at the same time, have them count the cards first and then read the words while driving their car.) First player to reach the end of the road wins.

Variation: Make it a road race! One player reads aloud each word along the road while you time how long it takes to get to the end. Then players switch roles (or remain the timer if your child is the only player). Players can complete the race multiple times and try to improve on their fastest time each turn. Rearrange the words and path of the road every so often for more challenge.

Parking Lot

Materials: Two pages of Word Cards, a blank Parking Lot game board for each player, and eight cars cut out from the Game Pieces page or eight small toy cars for each player

Preparation: Cut out the Word Cards and spread them out faceup. Each player copies eight words from the Word Card set onto a Parking Lot, writing one word per parking space. Then stack the cards facedown.

To Play: Players take turns reading aloud a Word Card to the group. If any of the players have that word on their Parking Lots, they drive their car into the parking space. Play continues until one player has a car parked in every space.

Bingo

Materials: Two or three pages of Word Cards, a blank Bingo board for each player, and pennies or paper squares to use as markers

Preparation: Cut out the cards and spread them out faceup. Players copy words from the Word Card set onto their Bingo boards, writing one word per square, until their boards are complete. (Each board should end up with some of the same words, but in a different order.) Then stack the cards facedown.

To Play: Players take turns reading aloud a Word Card to the group. If any of the players have that word on their boards, they place a marker over it. Play continues until one player gets four words covered in a row, in a column, or diagonally and shouts, "Bingo!"

SECTION 2:
Decoding Games

Word Cards

Directions: Use the word cards to play decoding games with your child as explained in the Game Directions.

cake

made

hope

nose

smile

white

try

stay

funny

SECTION 2:
Decoding Games

Word Cards

Directions: Use the word cards to play decoding games with your child as explained in the Game Directions.

boat

road

wait

rain

team

reach

need

green

true

SECTION 2:
Decoding Games

Word Cards

Directions: Use the word cards to play decoding games with your child as explained in the Game Directions.

farm

dark

torn

short

dirt

bird

turn

hurt

after

Directions: Use the word cards to play decoding games with your child as explained in the Game Directions.

toy

enjoy

join

point

loud

found

how

town

slow

SECTION 2:
Decoding Games

Word Cards

Directions: Use the word cards to play decoding games with your child as explained in the Game Directions.

room

soon

food

wood

took

foot

page

place

city

SECTION 2:
Decoding Games

Word Cards

Directions: Use this page to create additional Word Cards. Write the chosen words on the cards and then cut them out.

SECTION 2:
Decoding Games

Game Board

Directions: Use this template to create Parking Lot game boards. See the Game Directions for how to prepare each board and play the game.

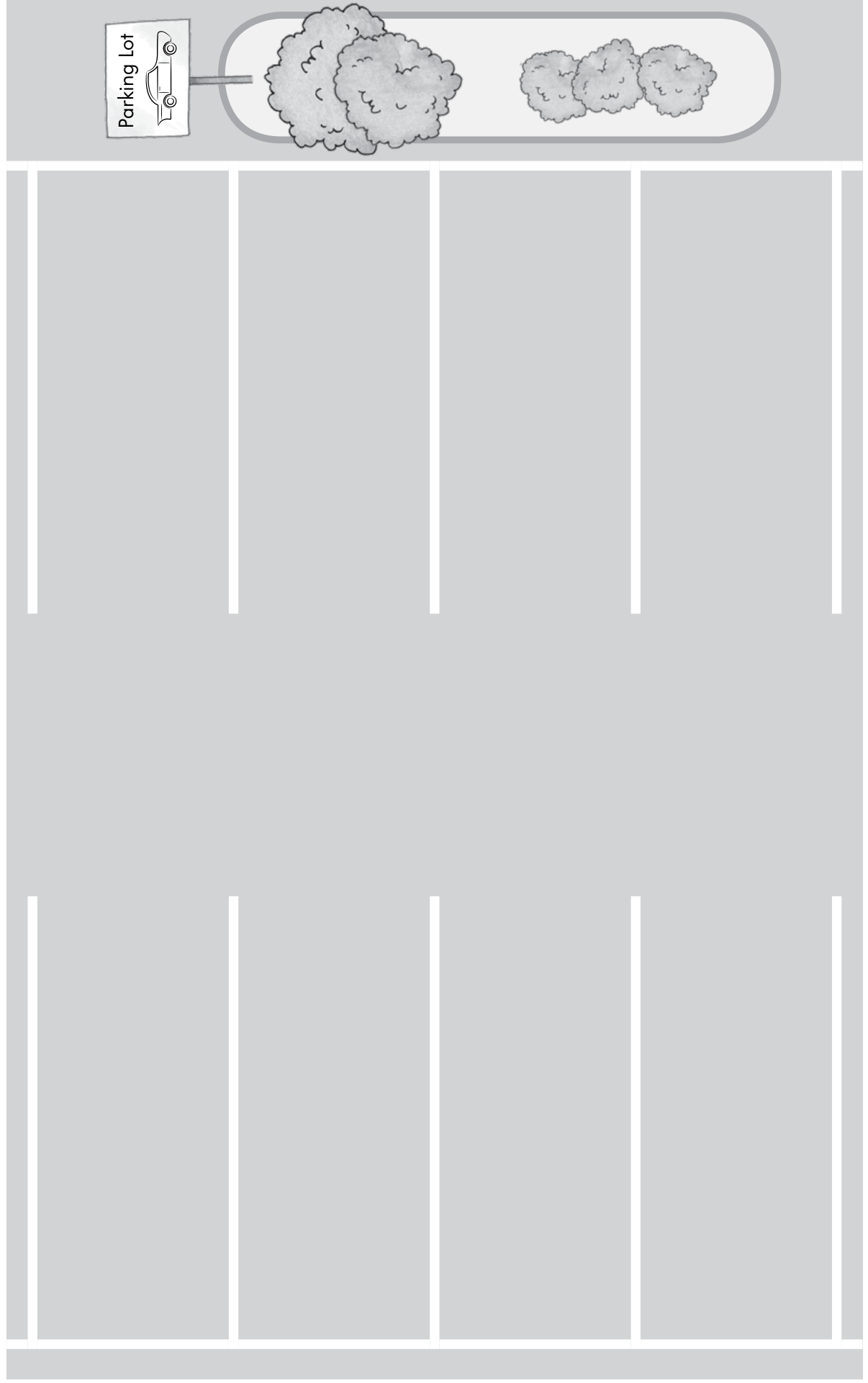

SECTION 2:
Decoding Games

Game Pieces

Directions: Have your child color the cars and cut them out to use in the game Parking Lot (8 cars per player), Road Trip (1 car per player), or Road Race (1 car per player). See the Game Directions for how to play the games.

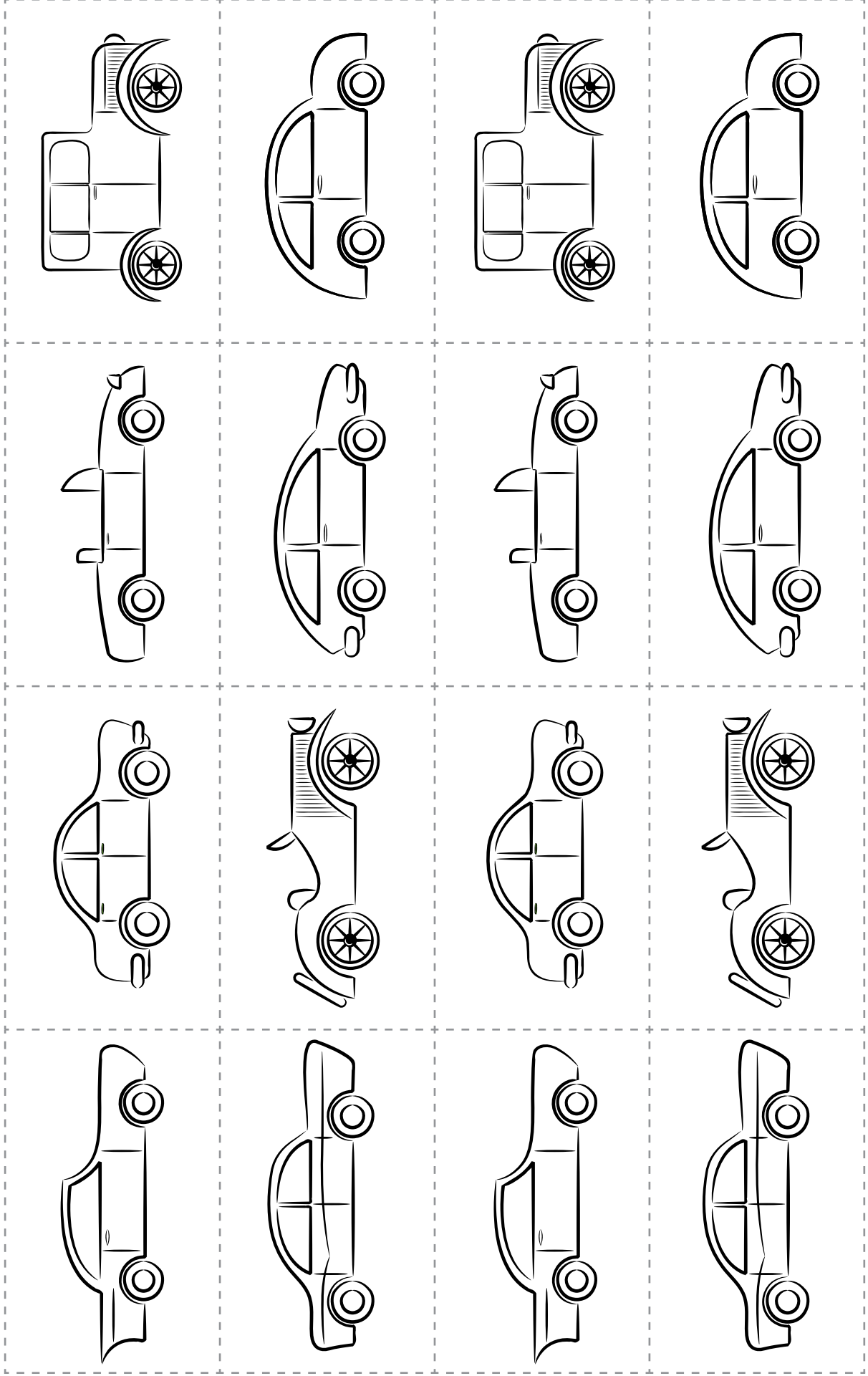

SECTION 2:
Decoding Games

Game Board

BINGO



Directions: Use this template to create Bingo boards. See the Game Directions for how to prepare each board and play the game.

SECTION 3: Reader Response



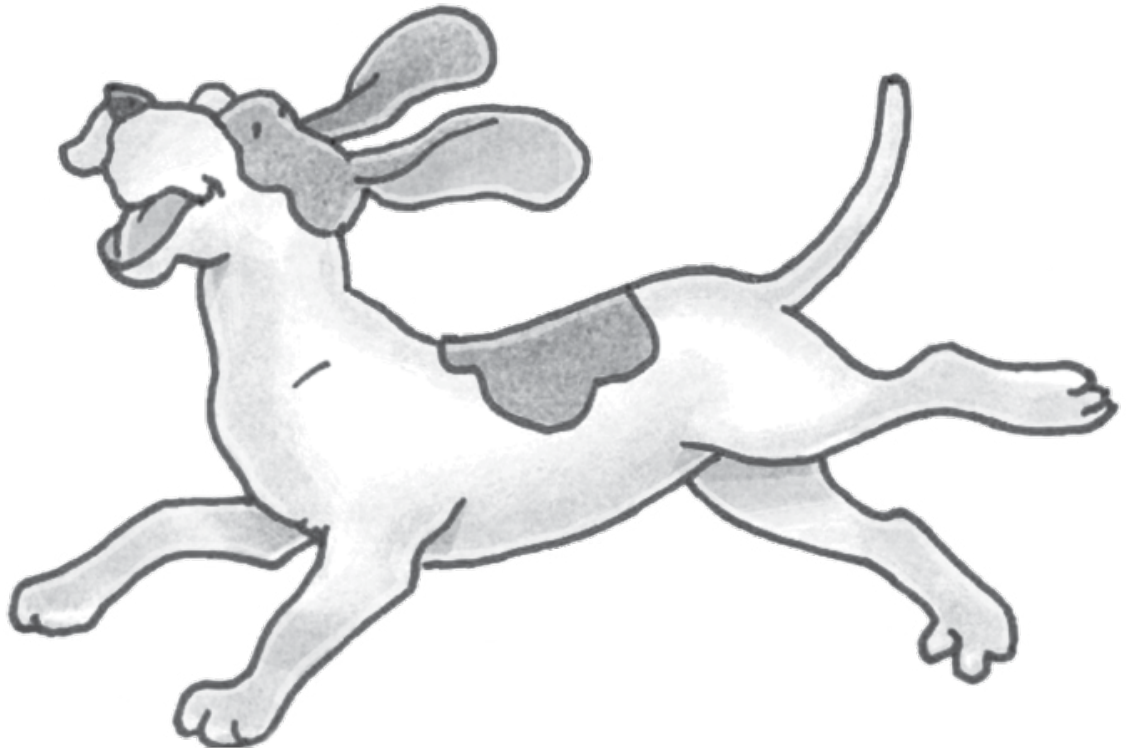

















- ★ Summer Reading Log
- ★ My Book Review
- ★ About a Story Character
- ★ About an Informational Book
- ★ Book Talk Questions



SECTION 3:
Reader Response

Summer Reading Log

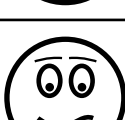
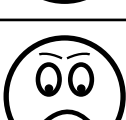
Directions: Help your child list the title of a book after reading it. Then have your child shade in the face that shows how he or she feels about the book.

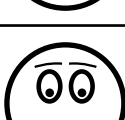
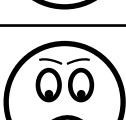
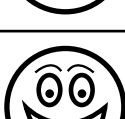
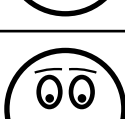
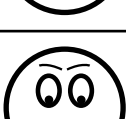
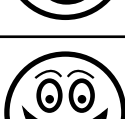
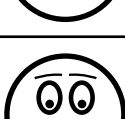
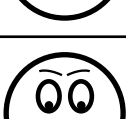
1.			
2.			
3.			
4.			
5.			
6.			
7.			
8.			
9.			
10.			

Book Title: _____

Author: _____

This book is about _____

I think the book is _____

Three reasons why I think so

1. _____

2. _____

3. _____

Picture of Best Part

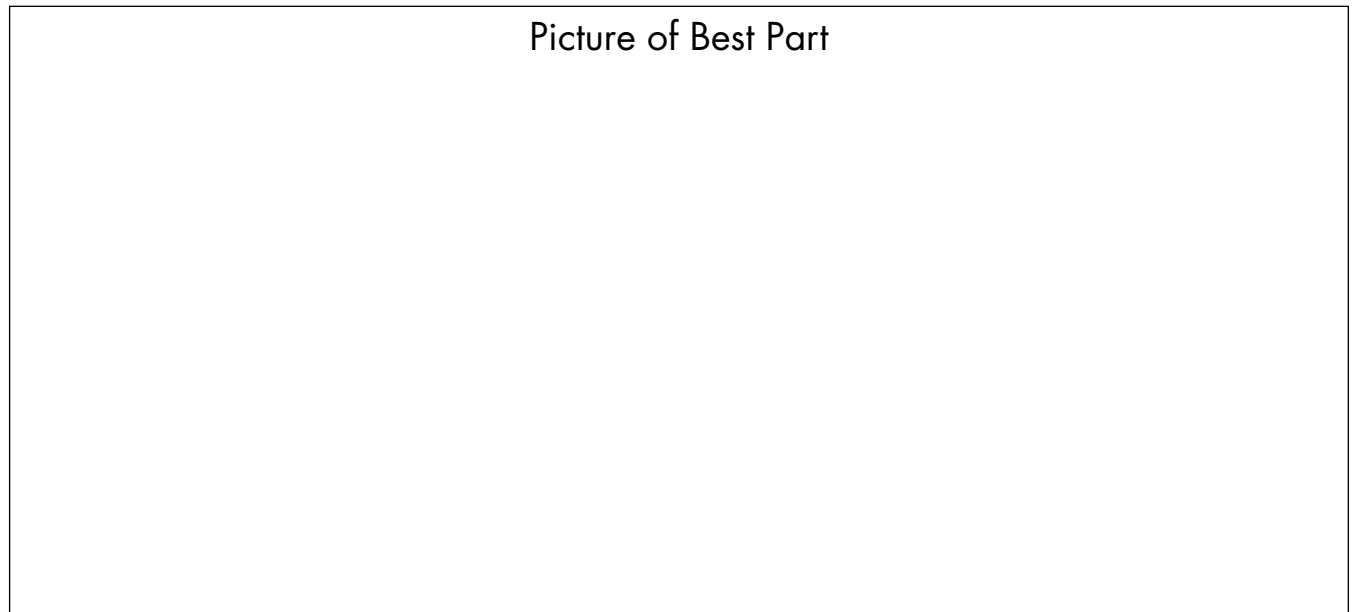

Character's Name: _____

from the Book _____

Character's Picture

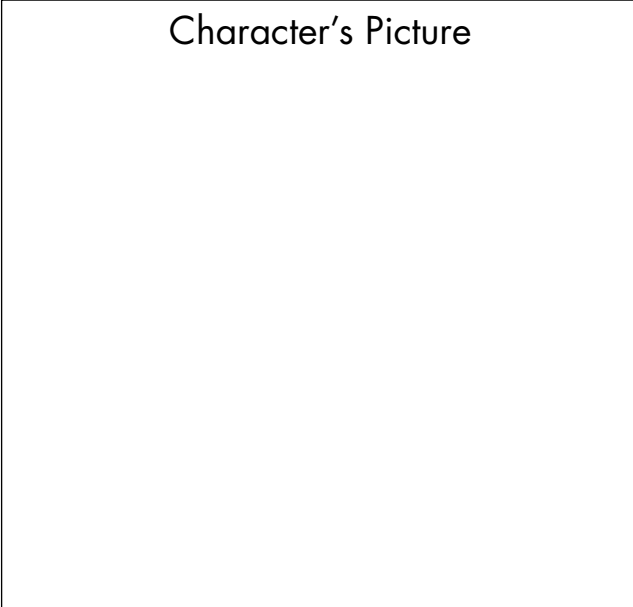

Character Traits (like brave, smart, silly)

- 1.
- 2.
- 3.
- 4.

What the character wants most

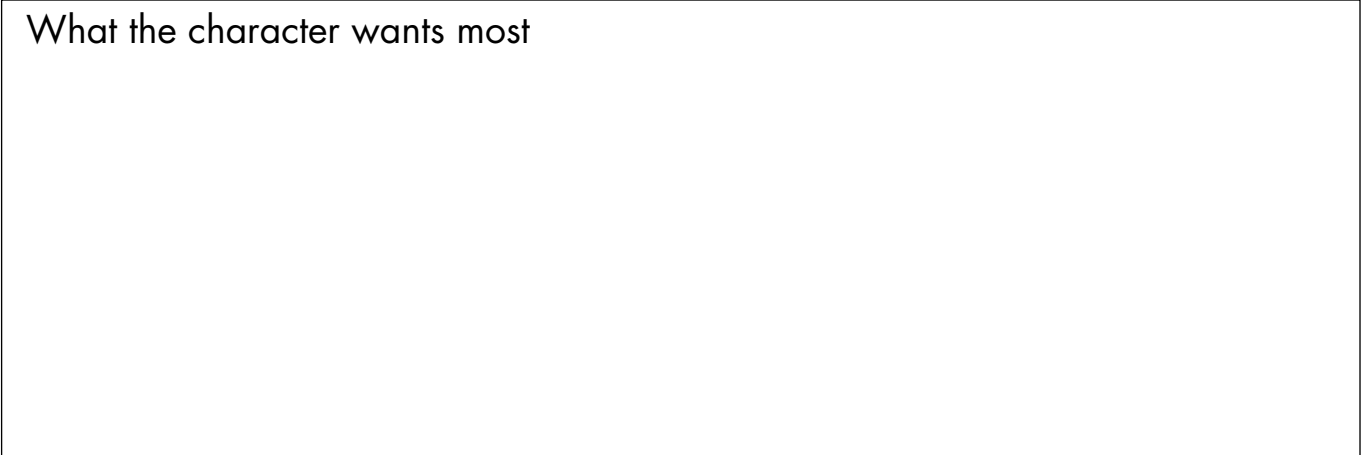

How the character changes or what he or she learns

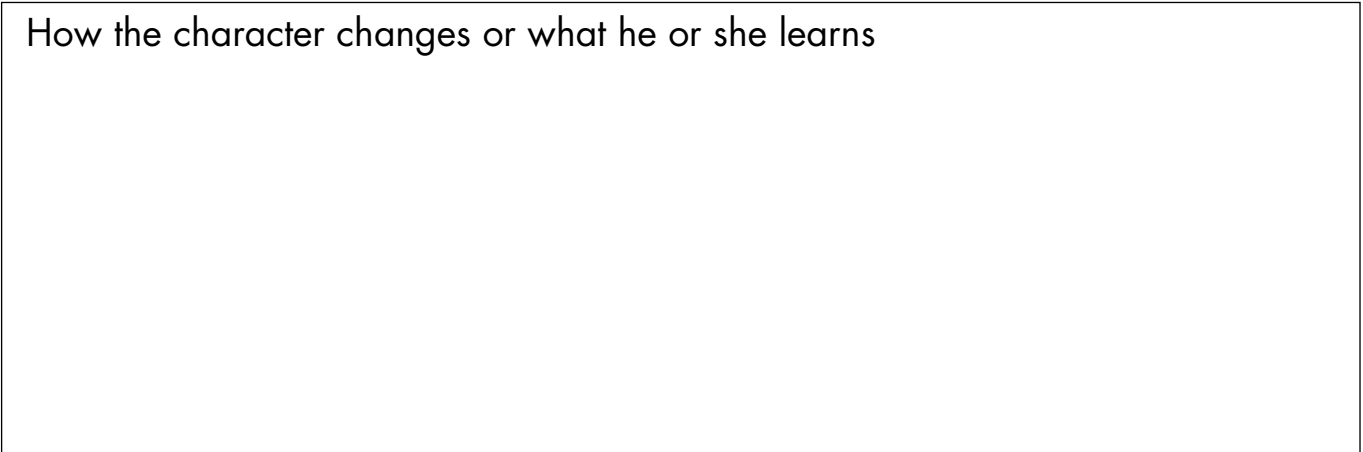

Title: _____

Author: _____

Most interesting thing
I learned about:

Fun Facts!

1.

2.

3.

Picture It!

Caption: _____

Directions: Have fun talking about books with your child! Tell each other the name and author of a fiction book you've read recently. (Note: You don't need to have read the same book.) Then take turns answering the questions below. You can roll a die or draw a number from a hat to determine which question to answer during your turn.

1. Tell about one of the main characters in the book. What is the person like?

4. Describe a setting where the story takes place. Why is this setting important for what happens in the story?

2. Who makes the most trouble for the main characters in the story? Tell what this character is like.

5. Describe how a character changes or learns a lesson in the story. What can you learn from this for your own life?

3. Describe a problem the main character has. How does the problem get solved?

6. Would you recommend the book to others? Why or why not?

FOR INFORMATIONAL TEXT

Directions: Have fun talking about books with your child! Tell each other the name and author of an informational book you've read recently. (Note: You don't need to have read the same book.) Then take turns answering the questions below. You can roll a die or draw a number from a hat to determine which question to answer during your turn.

1. What was the most interesting thing you read about in the book?

4. What did you think of photographs, illustrations, or diagrams in the book? How did they help your understanding?

2. Share two or three interesting facts from the book.

5. What idea do you think the author wants readers to remember most after reading the book?

3. Would you like to read another book about the same topic? Why or why not?

6. Would you recommend the book to others? Why or why not?

SECTION 4: Superkids Stories

- ★ Missing Coconut
- ★ The Hide-Out

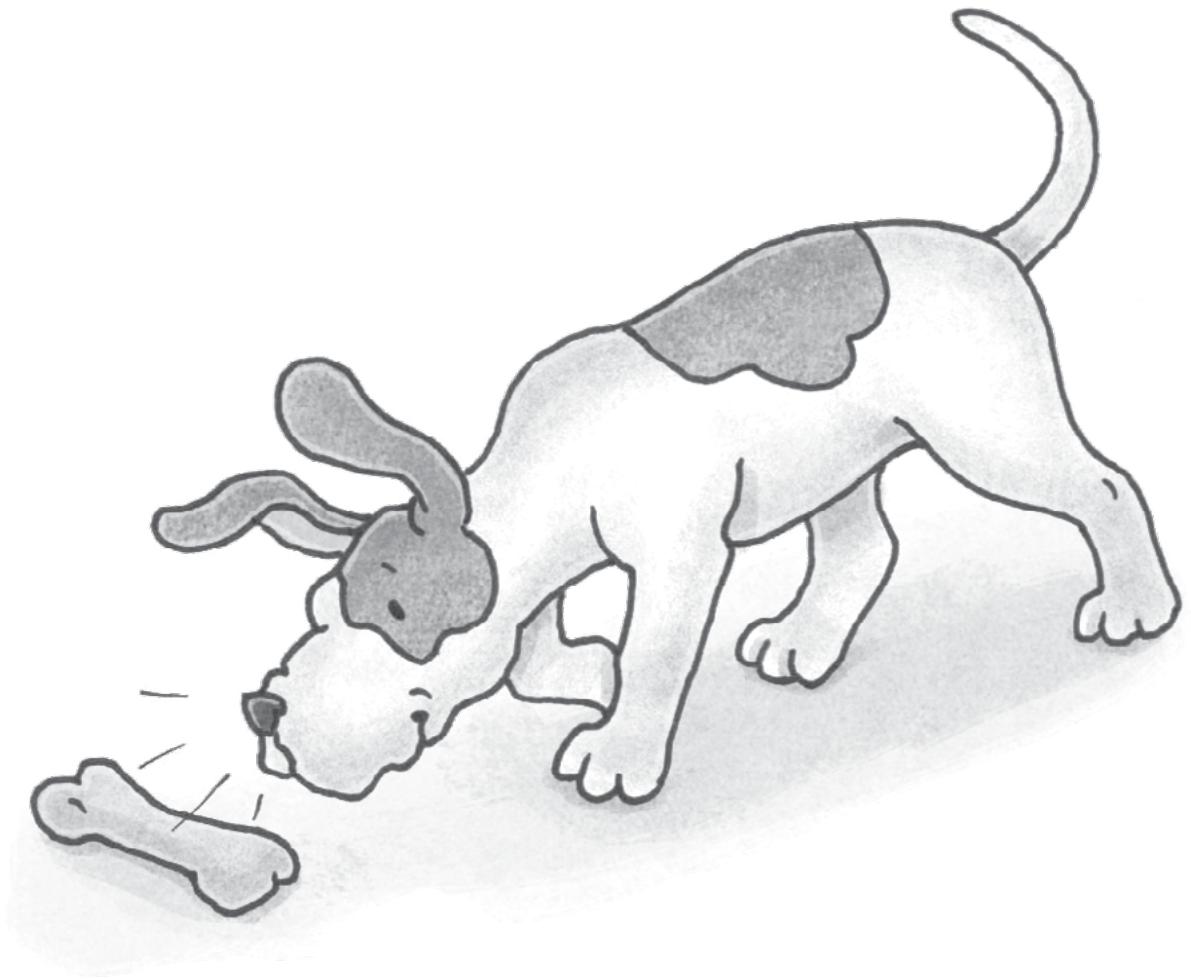

Missing Coconut

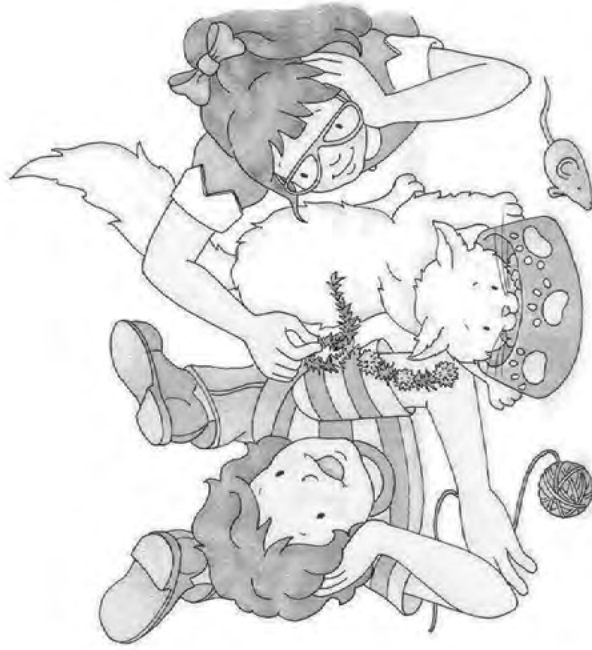

Written by Valerie Tripp

Illustrated by Meryl Henderson

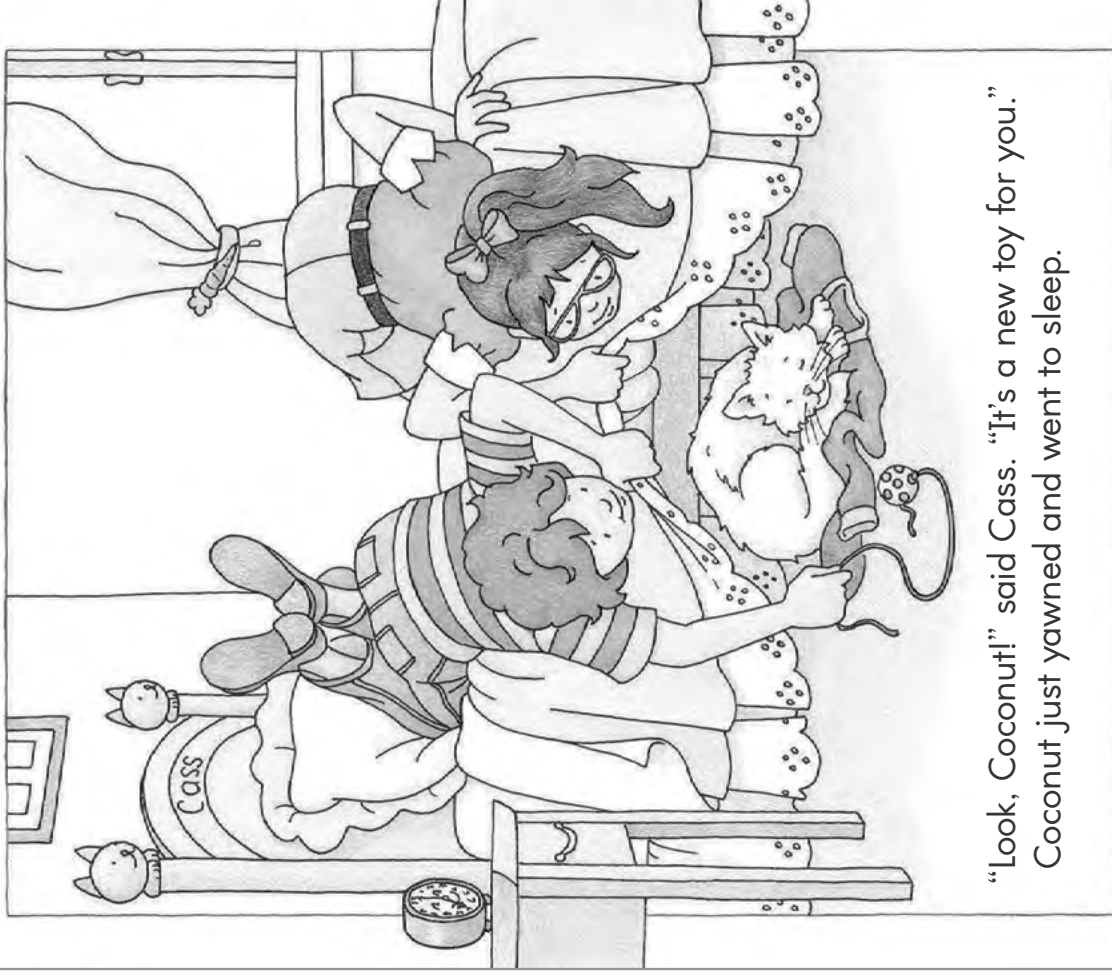

“Look, Coconut!” said Cass. “It’s a new toy for you.”
Coconut just yawned and went to sleep.

“Oh, Coconut,” Cass said. “All you do these days is sleep.”

“Is she sick?” asked Ettabetta.



“I hope not,” said Cass. “But I’ll take her to the vet for a checkup.”

“I’ll go, too,” said Ettabetta.

“Thanks,” said Cass. “Let’s get her case.”

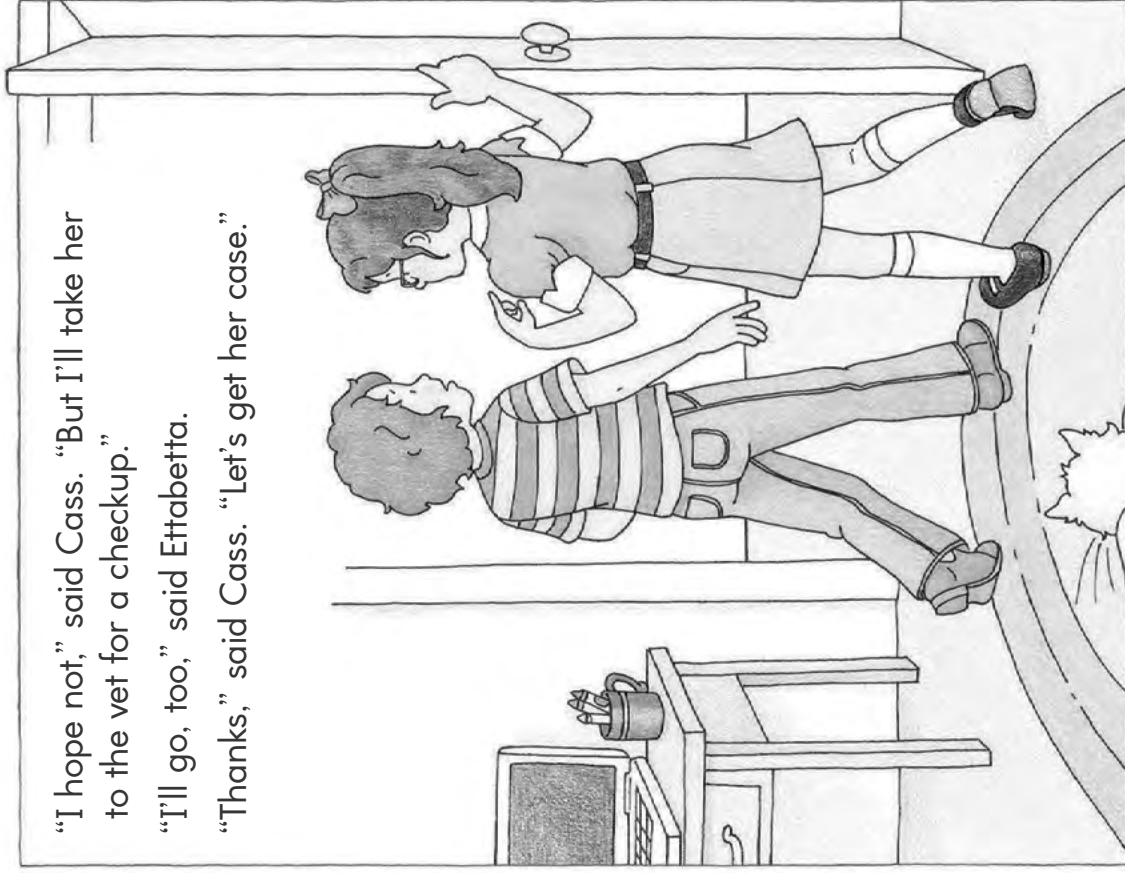

The girls went to the basement to get Coconut's case.

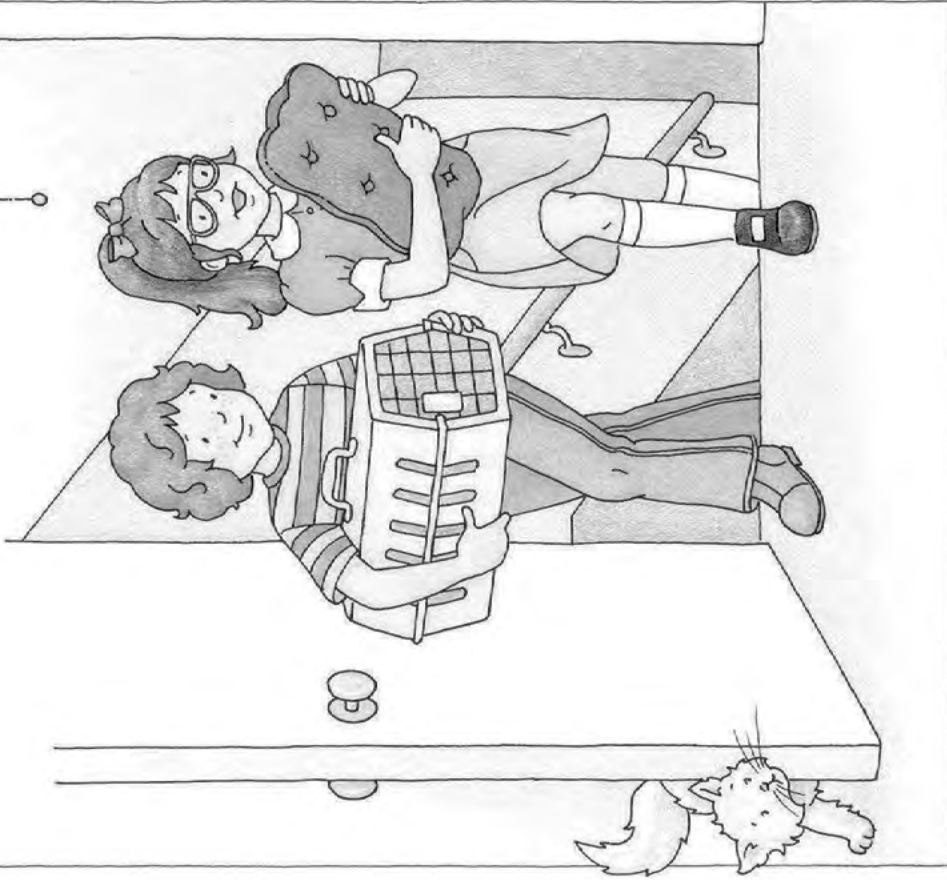

"Where did Coconut go?" asked Ettabetta.
"I don't know," said Cass. "But she must feel O.K. if she ran off like that. She'll come back when she feels like it."

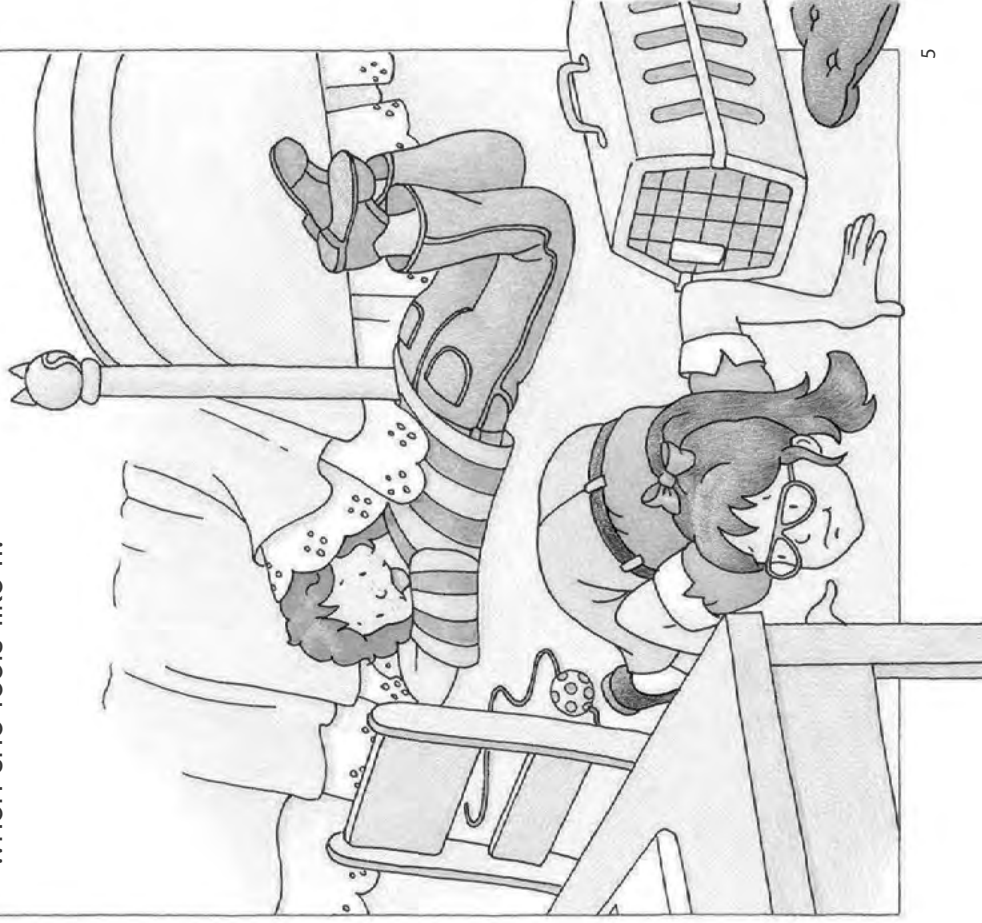

But Coconut did not come back that day
or the next day.

On the third day, Cass asked Ettabetta,
“Have you seen Coconut?”

“No,” said Ettabetta. “Is she still missing?”

“Sort of,” said Cass. “I have not seen her.
But I know that she has come home to eat.
I have filled her dishes every morning, and
they are empty at the end of the day.”

“So she just eats and then runs off again?”
said Ettabetta.

“Yes,” said Cass sadly. “I miss her.”

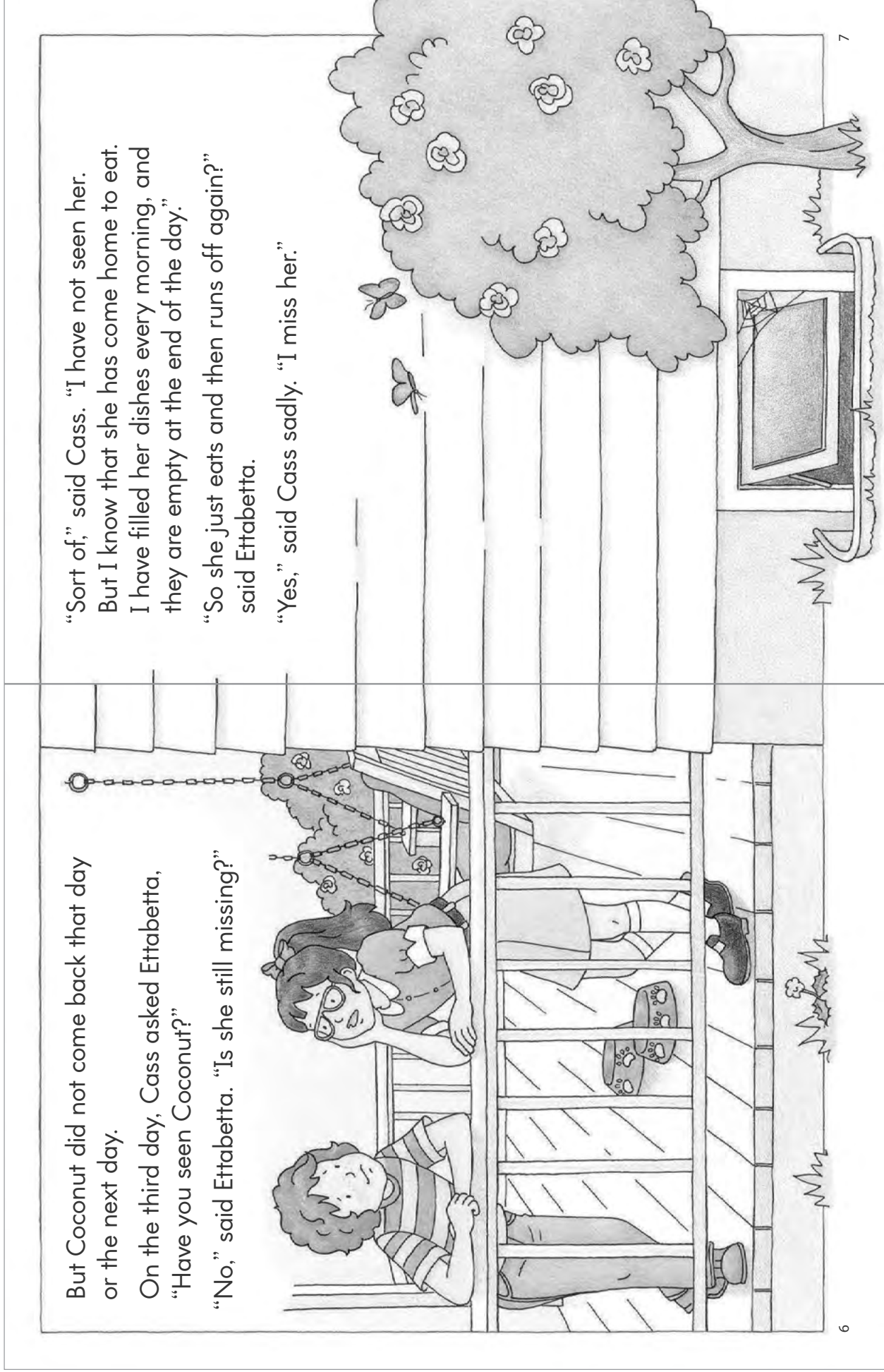

“Let’s fill Coconut’s dishes and then wait for her to come,” said Ettabetta.
“Good plan!” said Cass. “I’ll get her toys. Maybe she’ll stay and play.”



Cass and Ettabetta waited and waited.



At last, Coconut came!

“Hi, Coconut!” said Cass. “We are glad to see you!”

But Coconut ignored the girls.
She gobbled her cat chow.

“Stay and play!” said Cass.



But the second Coconut finished eating,
she ran away.

“Let’s follow her!” said Ettabetta.

“O.K.!” said Cass.

The two girls chased the cat.
But Coconut was too fast for them.
She disappeared.

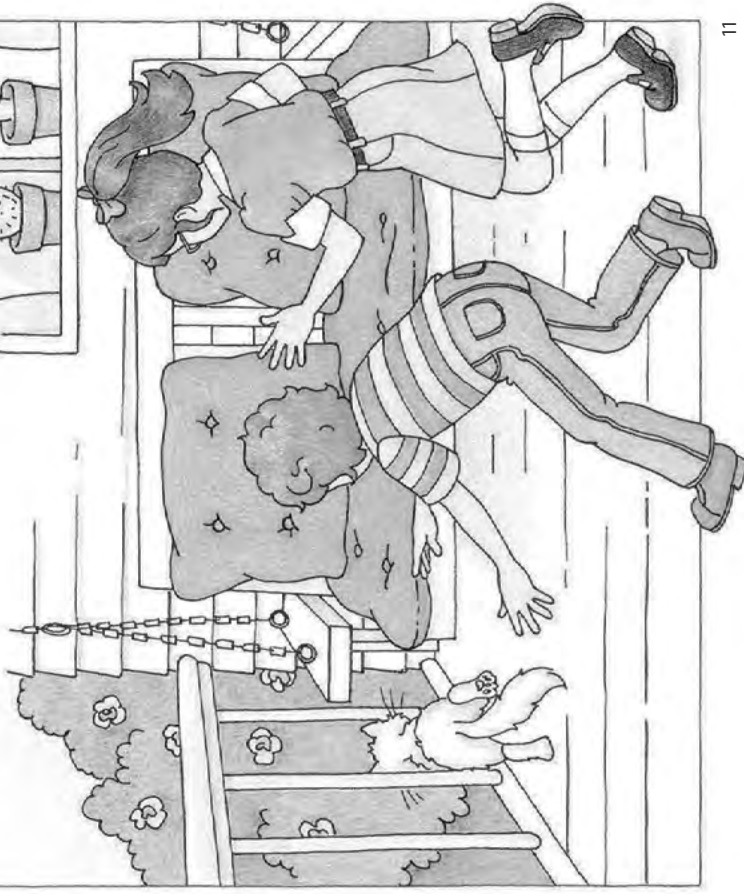

“Coconut has stopped liking me,” said Cass.
“She does not want to be my cat.”
“Coconut will always be your cat,”
said Ettabetta kindly. “She’ll come back
to play with you and stay with you.
Wait and see.”



The girls rested. They did not speak.
Suddenly, Ettabetta asked, “What is that sound?”
“It is coming from the basement,” said Cass.

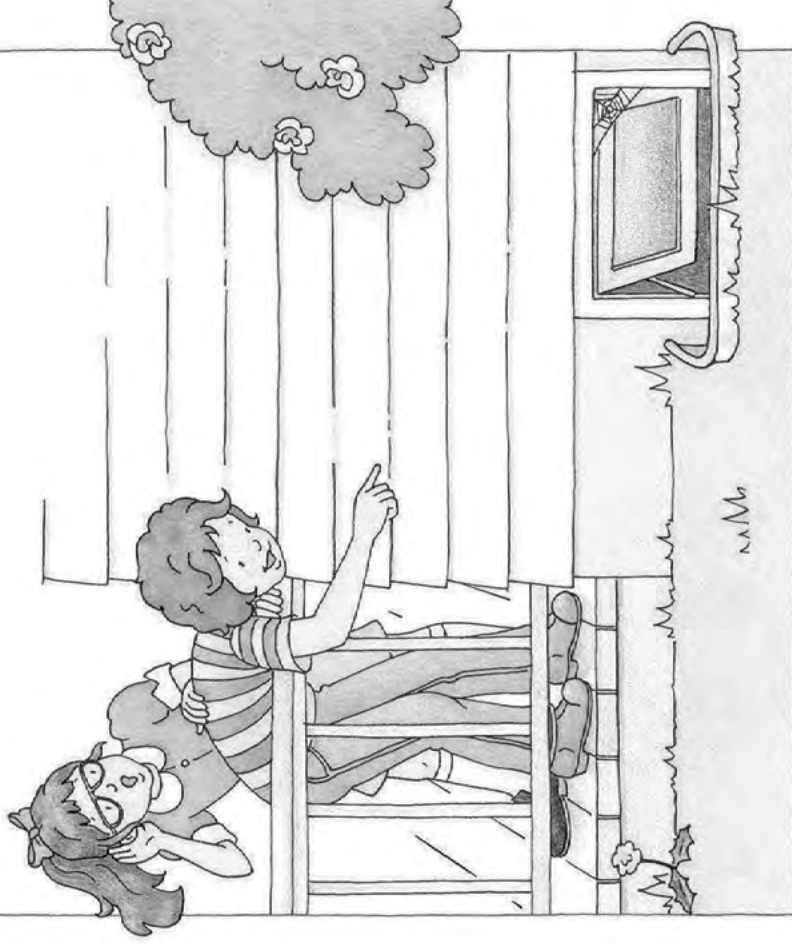

"It is Coconut!" whispered Cass.

"Close the window," said Ettabetta. "Then let's go see her."



Softly, the girls crept down into the basement.



“Kittens!” gasped Cass. “Coconut had kittens!”
“No wonder she didn’t stop to play,” said Ettabetta.
Coconut purred. The kittens made happy
little squeaks.

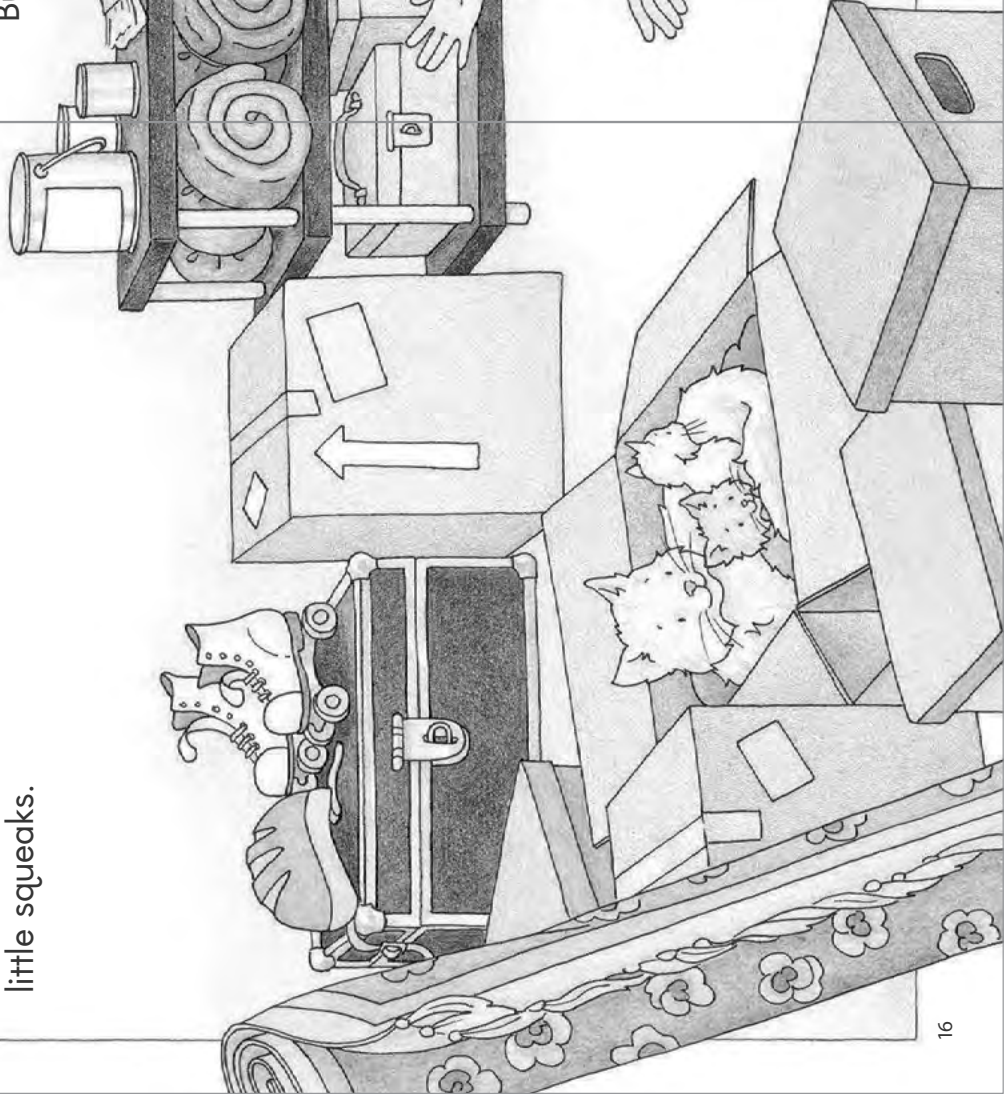

“What will you name them?” asked Ettabetta.

“Their mother is Coconut,” said Cass. “So I’ll call
the white one Marshmallow and the other one
Butterscotch.”



"I like that!" said Ettabetta.

"They are all very, very sweet!"



The End

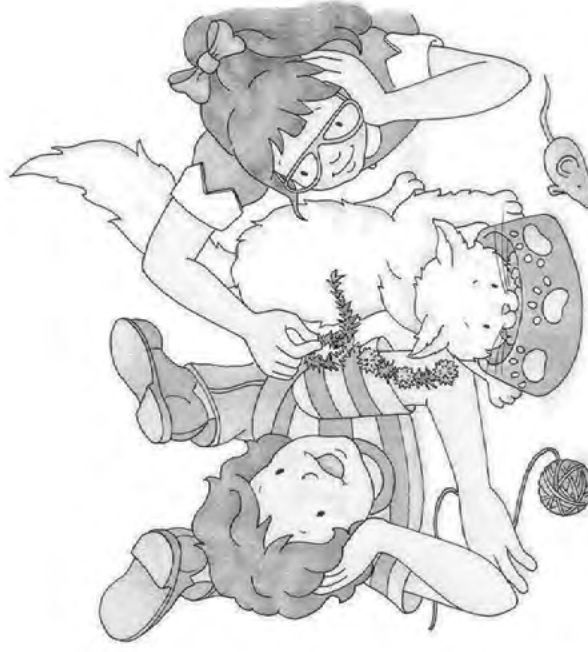

The Hide-Out



Written by Valerie Tripp
Illustrated by Meryl Henderson

One day, Hot Rod and Ettabetta discovered a hide-out.

"I bet this hide-out is hidden in the summer," said Ettabetta. "You can't tell it's here until the branches are bare. I bet we went past it a hundred times without seeing it under this tree before."

"Let's go in," said Hot Rod.

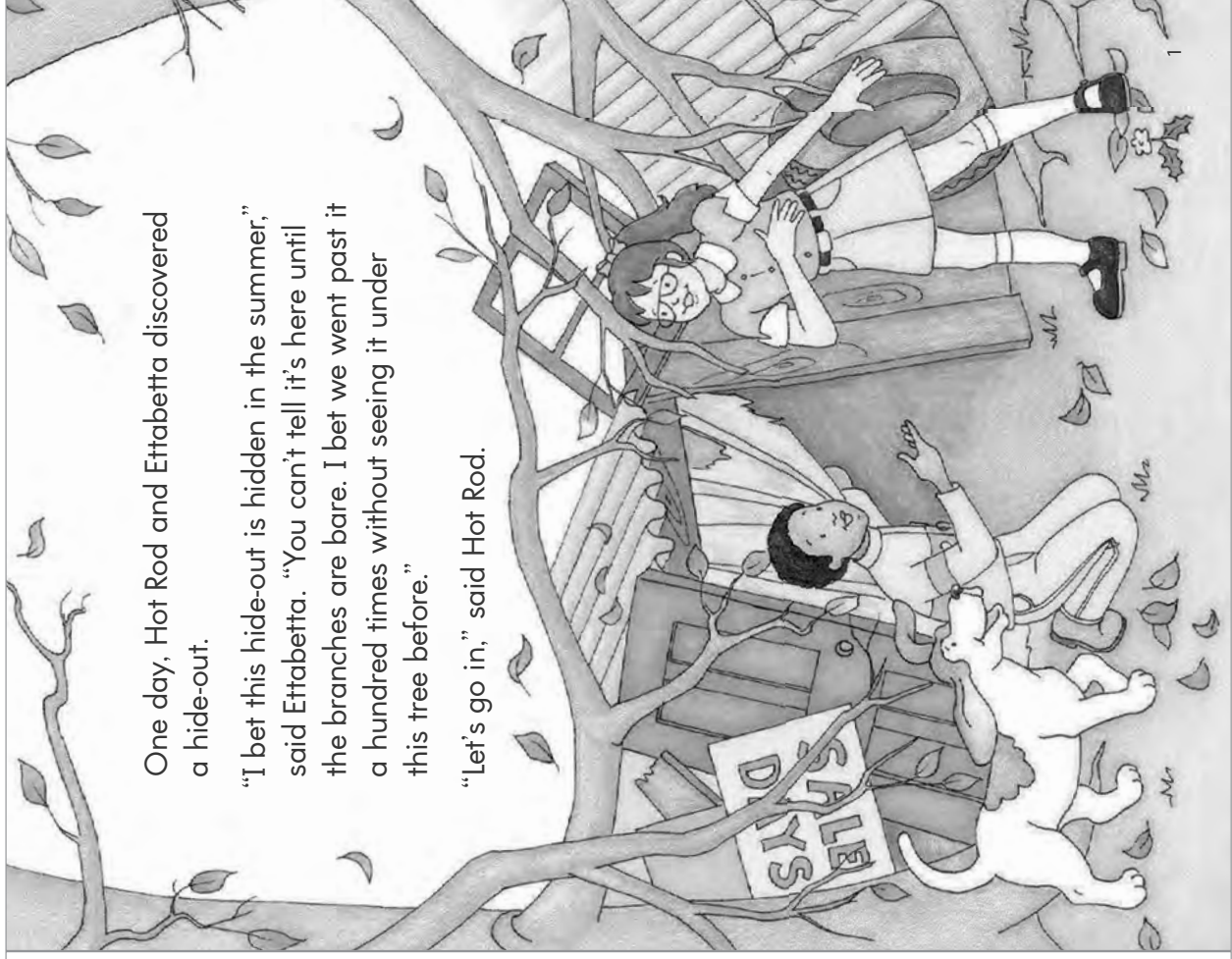

The hide-out was in bad shape. The sides tilted in. The top was caved in. It was a mess.

But Hot Rod said, "It is like a cave! I like it!"

"It smells like rotten frogs," said Ettabetta. "And I can't stand up in it. But I think it is terrific!"



"I wonder who made this," said Ettabetta. "It looks like it was made a long, long time ago. Perhaps cavemen made it!"



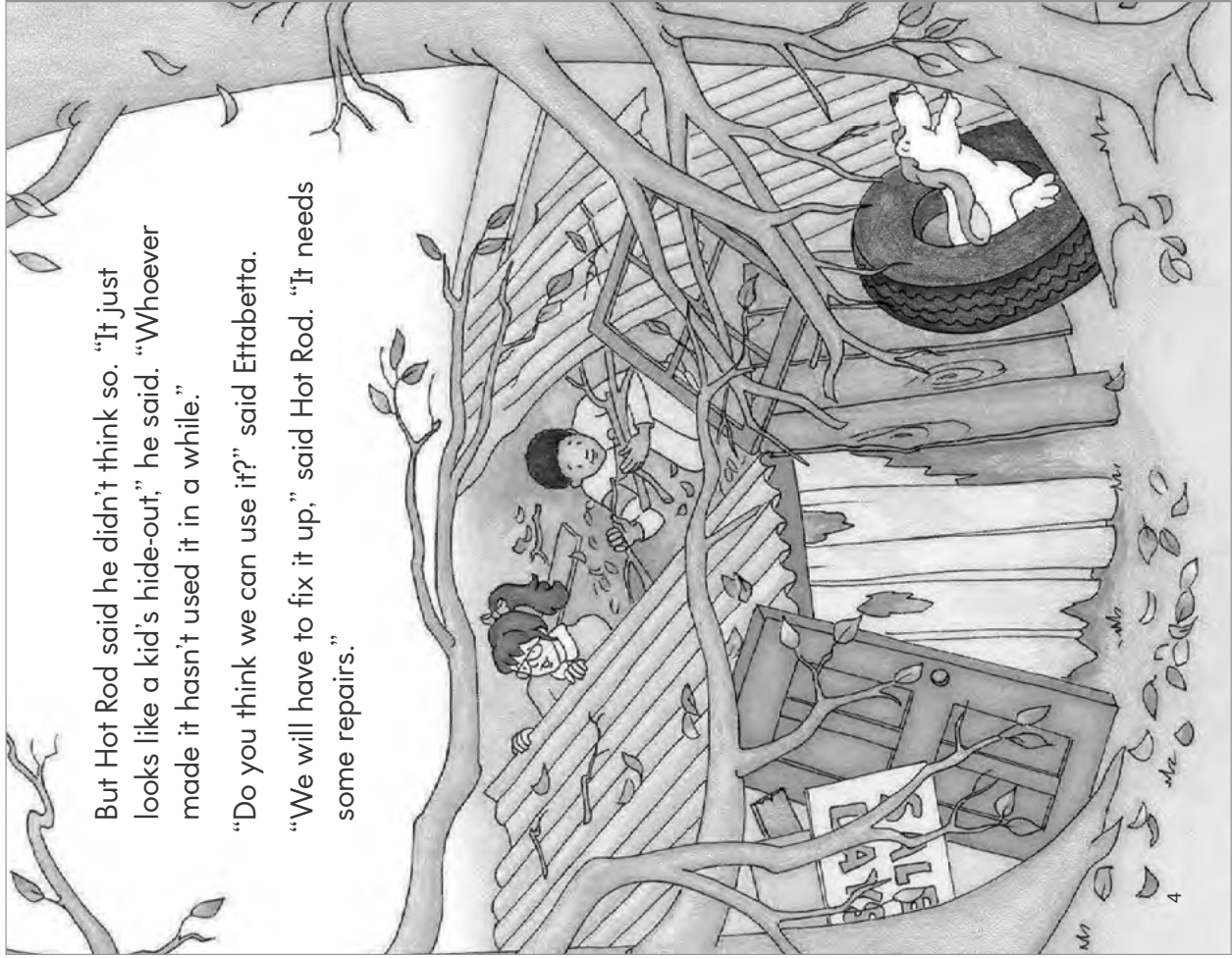

But Hot Rod said he didn't think so. "It just looks like a kid's hide-out," he said. "Whoever made it hasn't used it in a while."

"Do you think we can use it?" said Ettabetta.

"We will have to fix it up," said Hot Rod. "It needs some repairs."

"You bet!" said Ettabetta. "Let's make it a lot bigger. Let's put it up on stilts and make a ladder! We can dig a tunnel to the pond. I bet we can save up and get a TV or a swinging hammock to put inside."

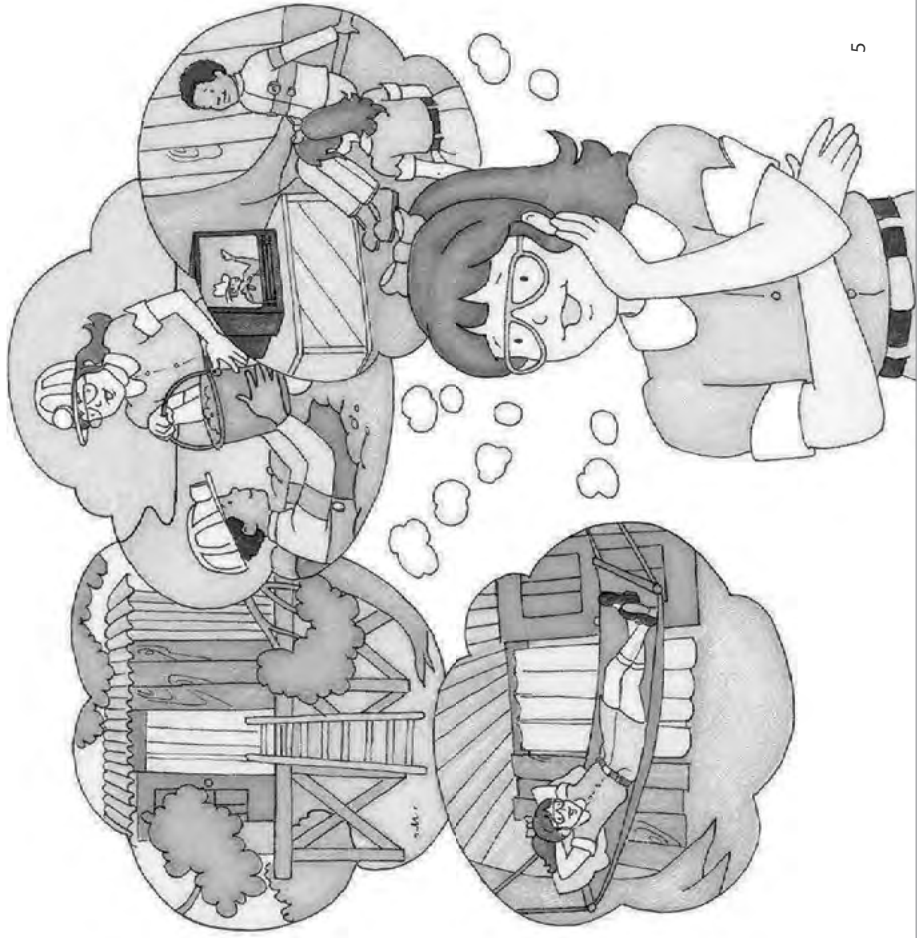

But Hot Rod said he didn't think so.

"You don't put stuff like that in a hide-out," he said.

"Do you put ANYTHING in a hide-out?" asked Ettabetta.

"Just a blanket to sit on," said Hot Rod. "I will ask Gus if he has a blanket we can use."

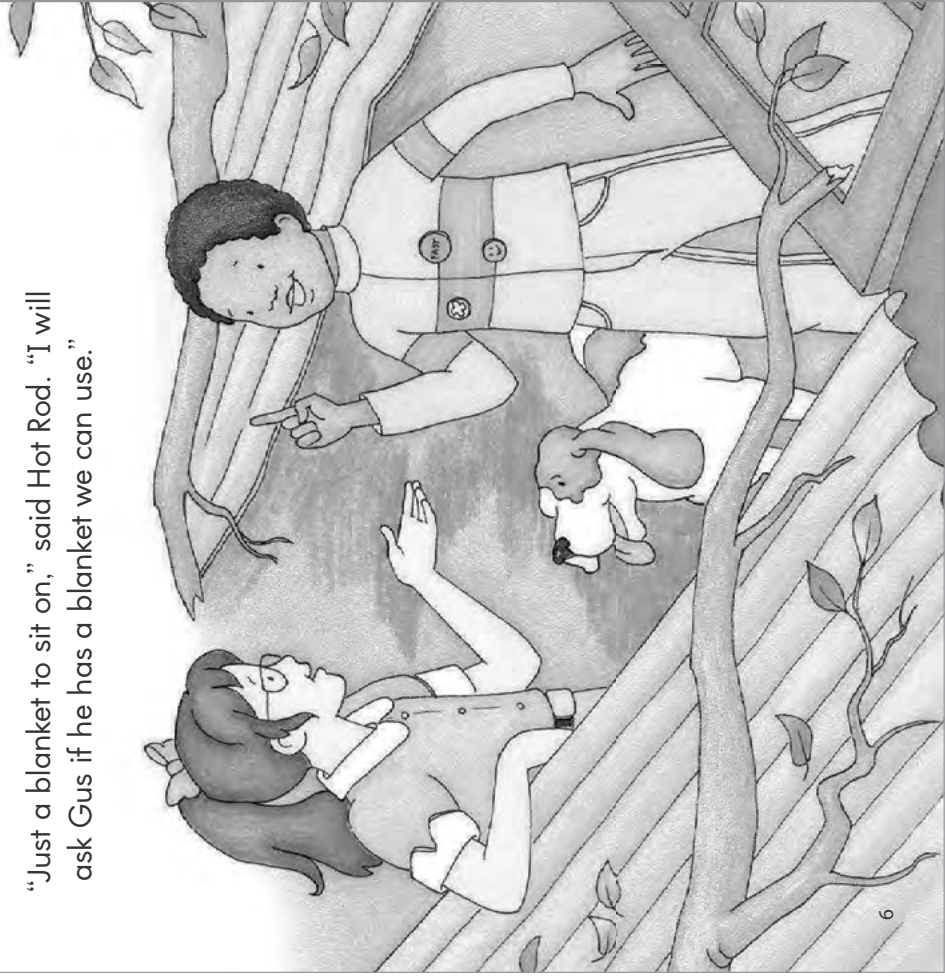

"Oh, no!" said Ettabetta. "You can't tell Gus we have a hide-out! And you can't tell Gert or any of the Superkids. A hide-out is no good if you tell."

"O.K.," said Hot Rod. "I won't tell anyone about it."

Ettabetta made Hot Rod shake hands on it.



Hot Rod and Ettabetta spent the week fixing up the hide-out. There was a lot of raking and cleaning to do.

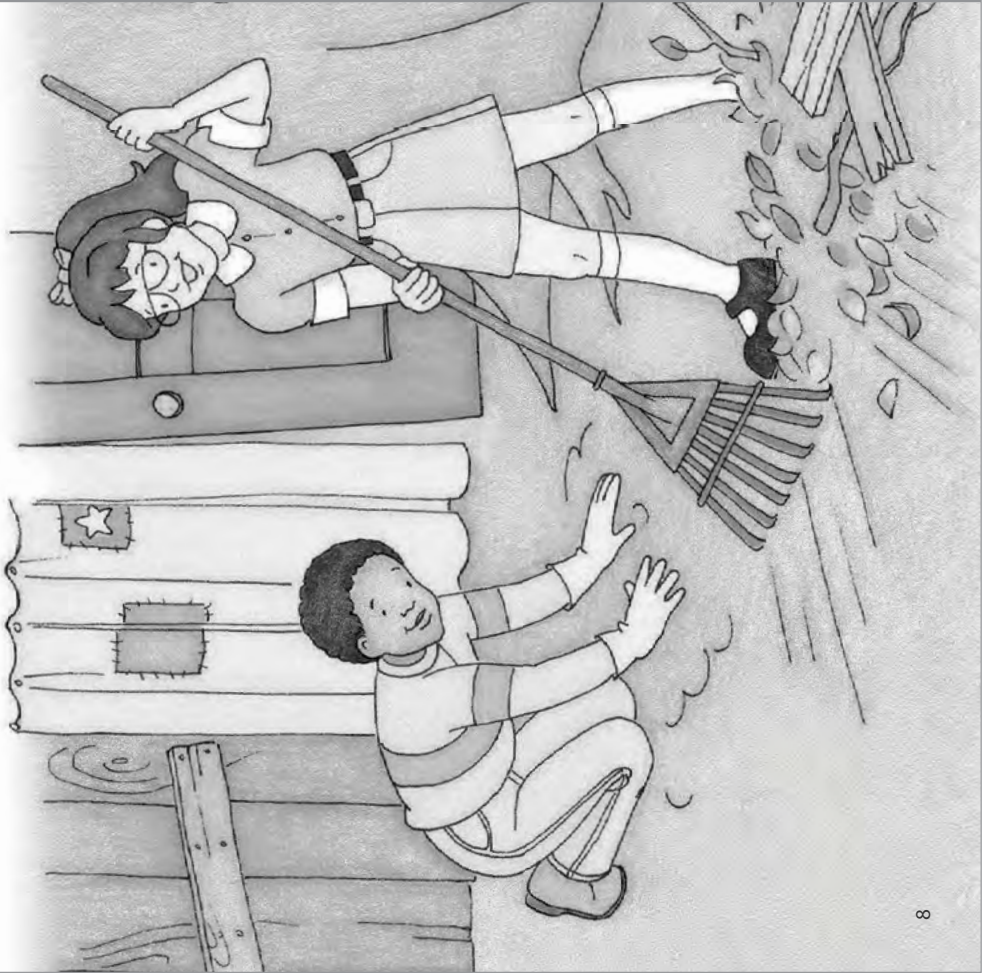

One day, Hot Rod and Ettabetta went to see Gus and Gert. Gus said, "I have not seen you two for a while. What are you kids up to these days?"

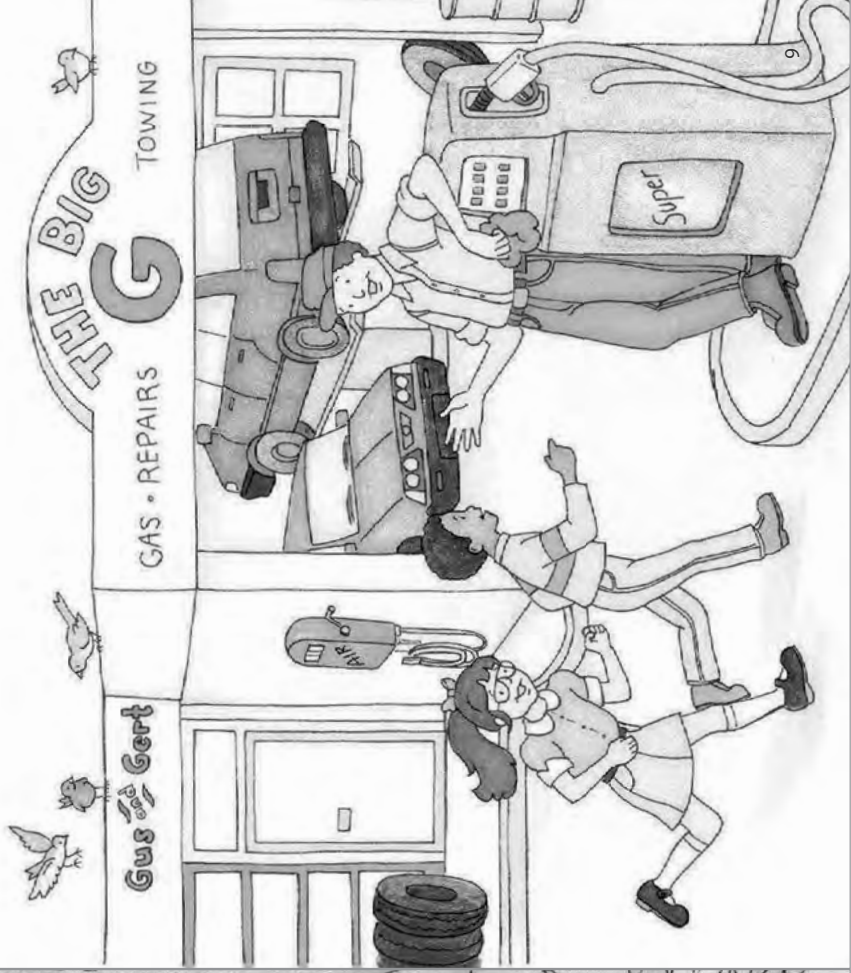

“Just playing at the pond,” said Hot Rod.

“What were you doing there?” asked Gert.

Hot Rod looked at Ettabetta. Ettabetta looked at Hot Rod. “Nothing!” the two kids said.

“Well,” said Icky. “Whatever you are doing, you had better stop. You smell like rotten frogs.”

Gert smiled at Hot Rod and Ettabetta. She said, “You smell O.K. to me. I am glad you came to help Gus and me.”

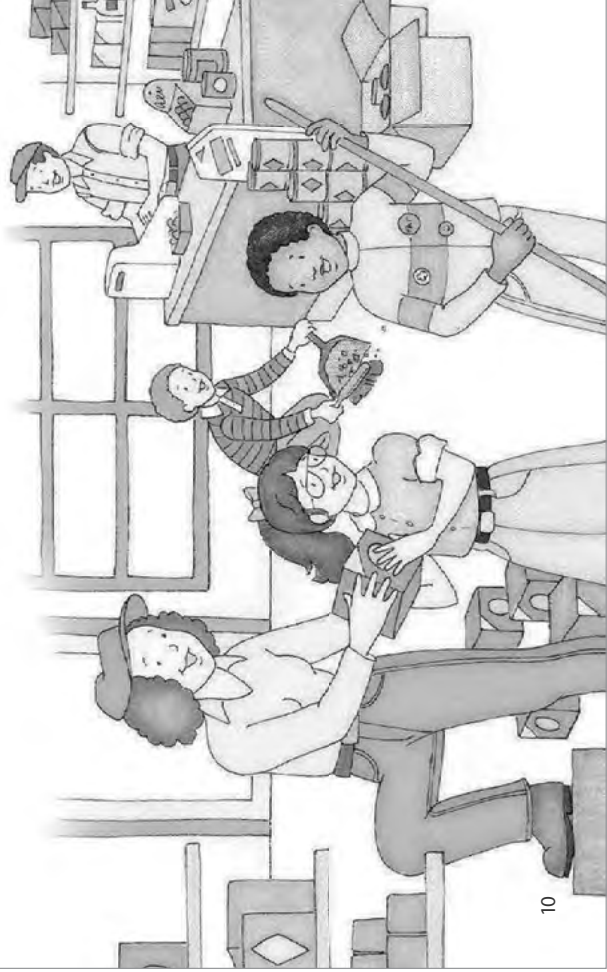

When Ettabetta and Hot Rod got to the hide-out the next day, there was a bag of big red apples inside it.

“Did you put these here?” Ettabetta asked Hot Rod.

“No,” he said.

“Did you tell?” Ettabetta asked.

Hot Rod gave Ettabetta a disgusted look.

“No!” he said.

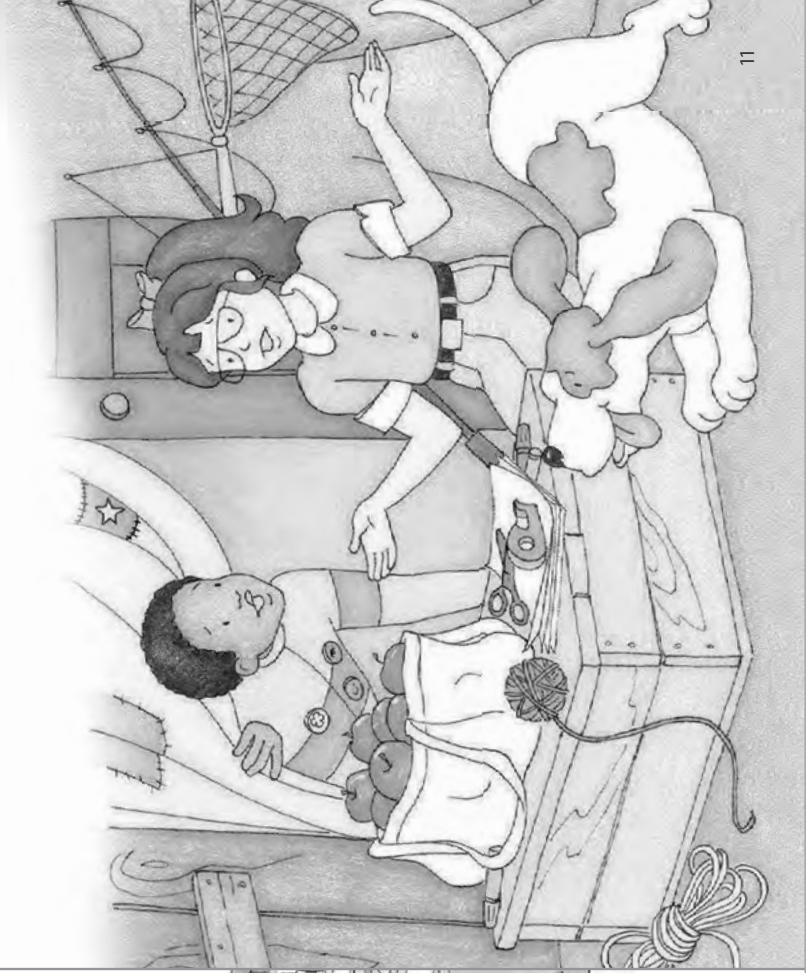

“Well, then, who left these apples here?” Ettabetta asked.
Hot Rod said nothing. He bit into an apple.



“What if an enchanted green frog left these apples?”
Ettabetta said. “Perhaps a monster left them. I wonder
if it was a little person from another planet.”

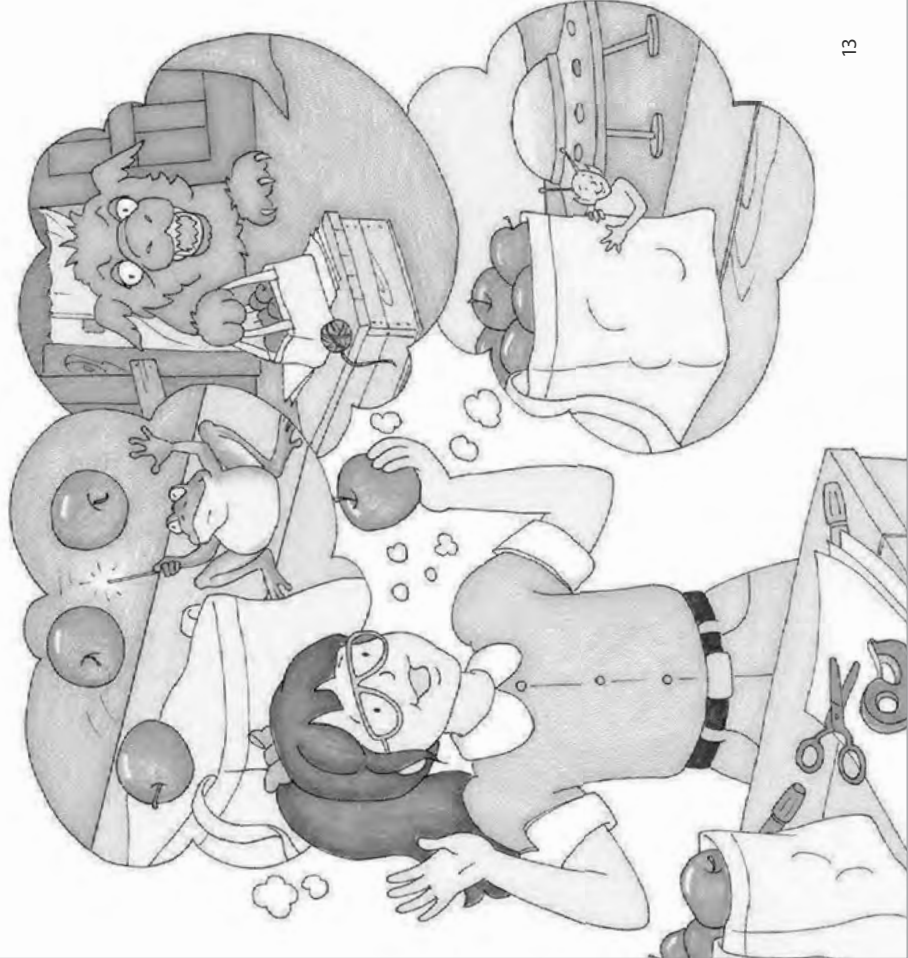

Hot Rod said he didn't think so.
"I think Cass left the apples," said Hot Rod.
"It was not Cass!" said Ettabetta. "She would not have liked it in here. She hates mud and frogs. I bet a gang of spies left these apples."

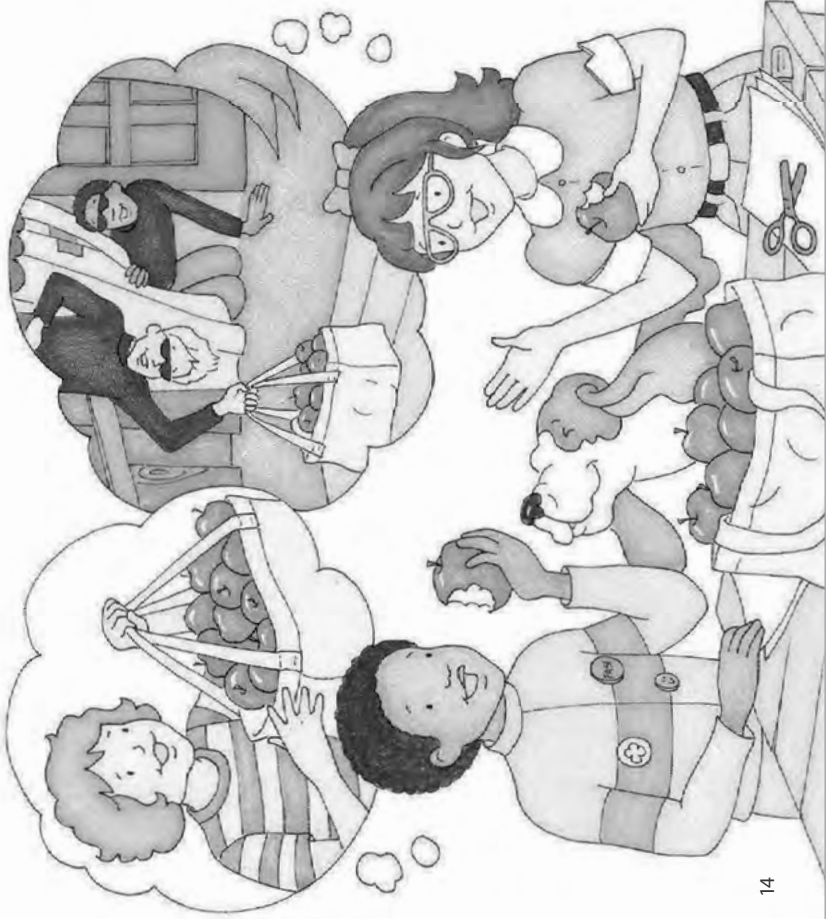

The next day Ettabetta dashed to the hide-out to see if the spies had left anything.
There was an envelope for Hot Rod and Ettabetta! Inside the envelope there were five dimes for Hot Rod and five dimes for Ettabetta.
"It must be spies," Ettabetta whispered to Hot Rod.
"How can we catch them?"

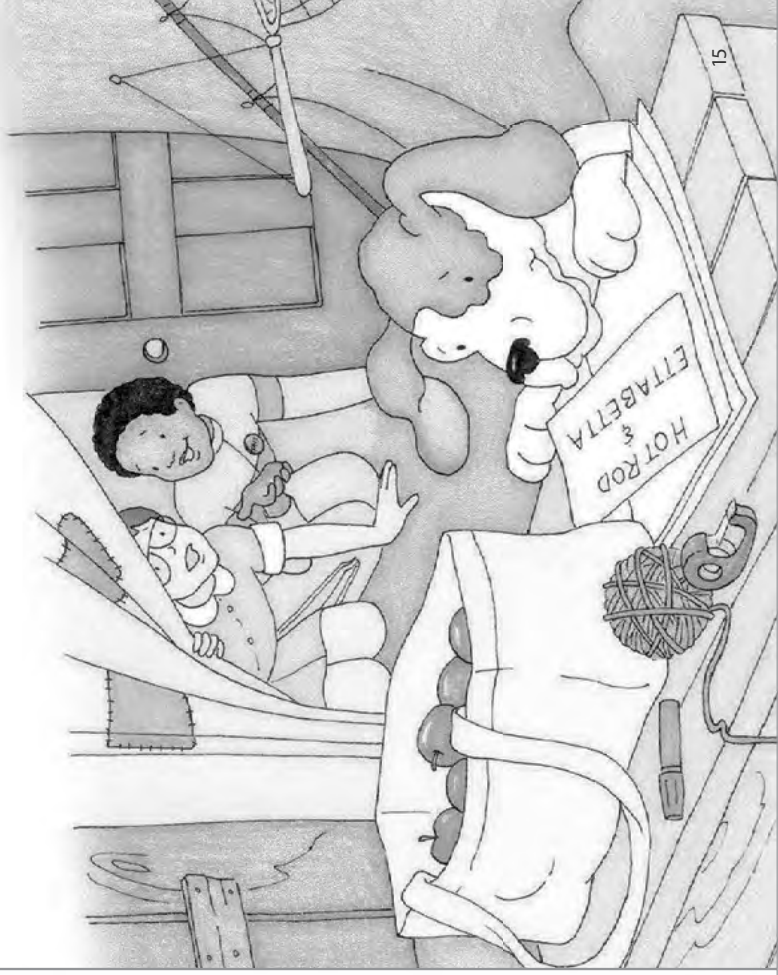

“We can dig a hole in front of the hide-out and put the blanket on top of it. Then the spies will step on the blanket and tumble into the hole!” said Ettabetta.

“We can hang a net on a branch and the spies will get tangled up in it!” said Ettabetta.

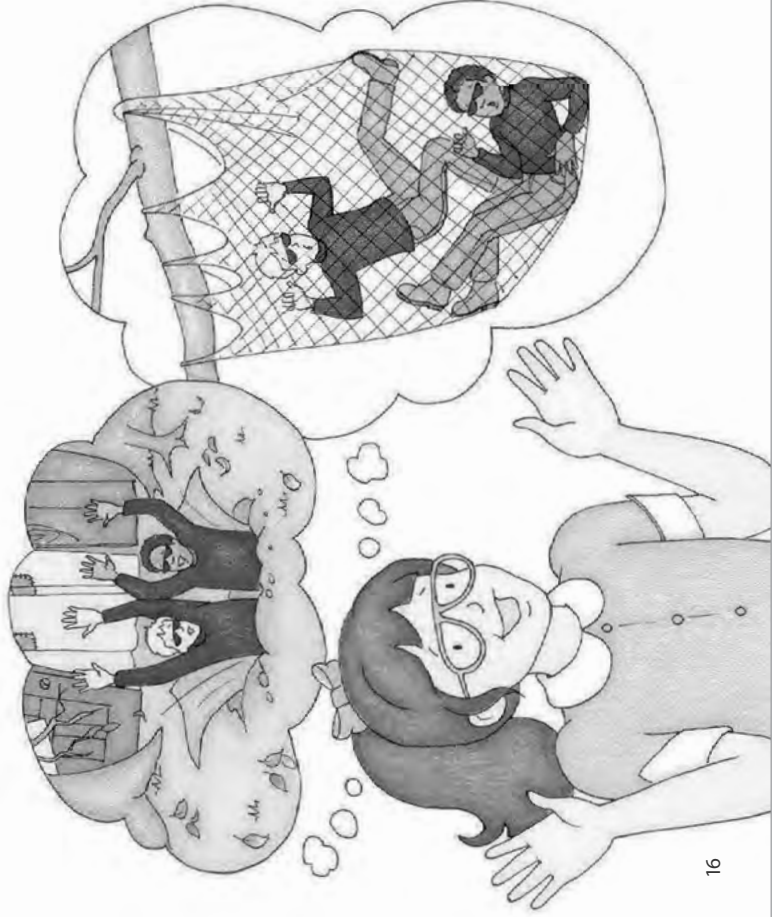

“We can scare them. We can make a web out of string and put a rotten banana peel in it!” said Ettabetta.

“Let’s put gum in the hide-out. The spies will step on it and get stuck!” said Ettabetta.

“We just have to catch them!” said Ettabetta.

Hot Rod said he didn’t think so.

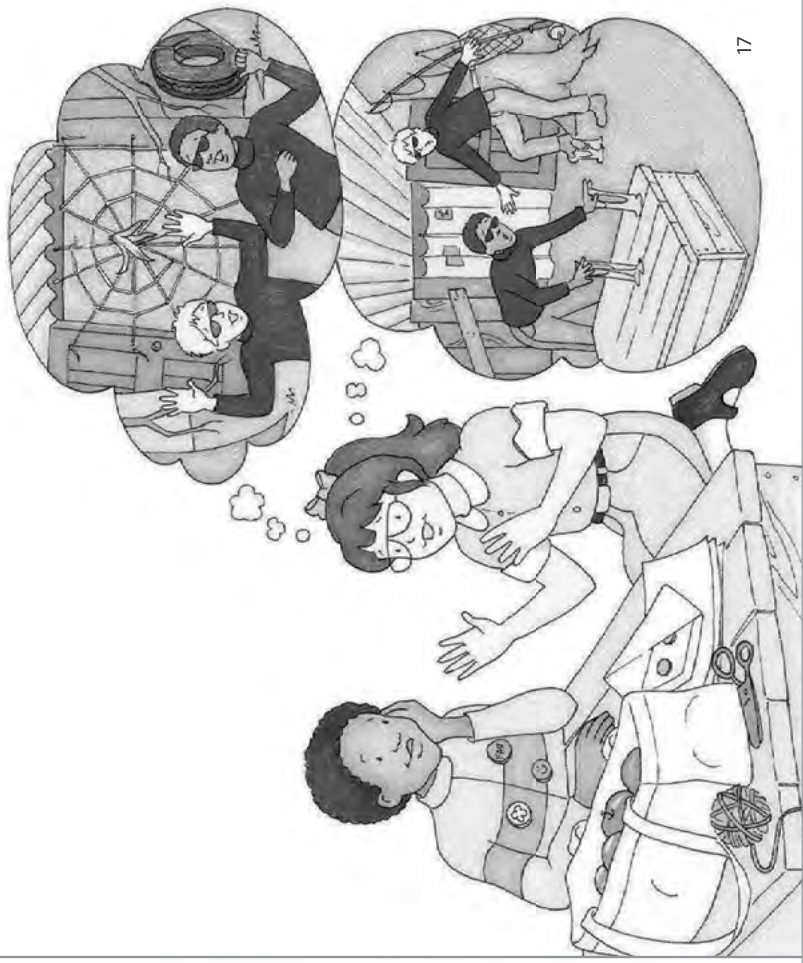

Hot Rod said, "Let's tape a note to the hide-out. Let's ask the spies who they are."

"A note?" Ettabetta said. "You can't just send spies a dull note. You are supposed to use a code."

Hot Rod said he didn't think so. But Ettabetta said the note just had to be in code. So she taped this note to the hide-out:

Q
U
O
N
?
A
R
E
M
H
O

Ettabetta wanted to use invisible ink but she didn't have any.



The next day Hot Rod and Ettabetta got this:

9 1-13 1 16-1-12
Hint: 1-2-3 is A-B-C

"What is this?" asked Hot Rod.

"The spies sent us a note in code!" said Ettabetta. "Isn't it fantastic?"

"O.K., O.K.," said Hot Rod. "But what is the code?"



"Look at the hint," said Ettabetta. "1-2-3 is A-B-C. Get it?"

"No," said Hot Rod.

"It's simple," said Ettabetta. "The numbers in the code stand for letters. 1 is A. 2 is B. 3 is C. 4 is D. And so on. It will only take me a second to read the note."

The note said, "I am a pal."

"A pal!" said Ettabetta. "How can spies be pals?"

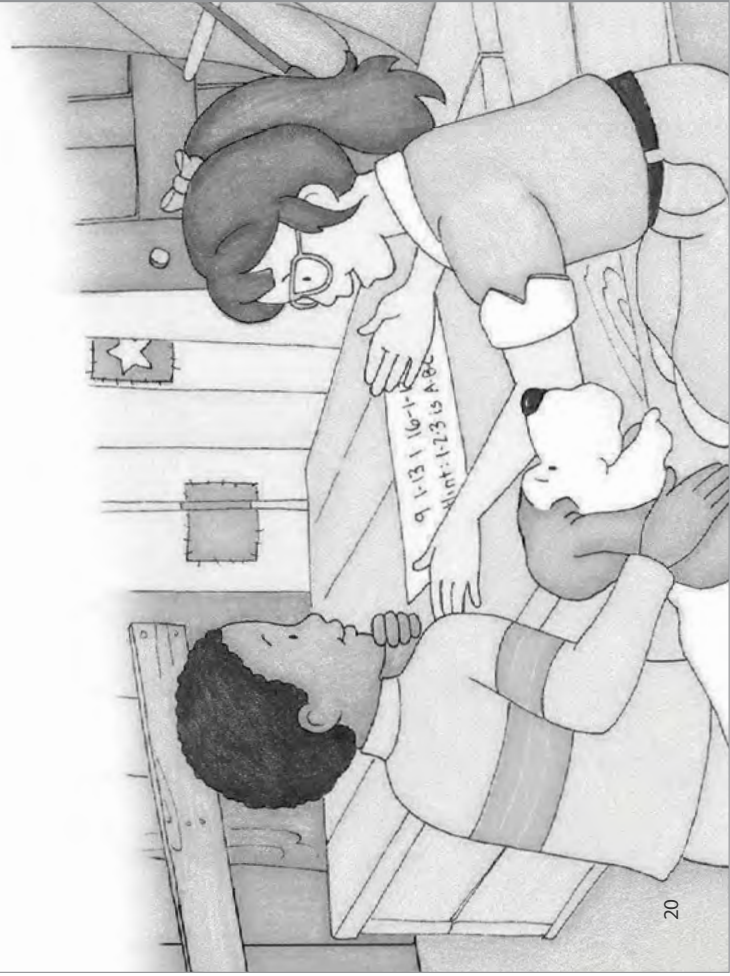

Hot Rod said, "Let's tell the spies we want to get together."

"O.K.," said Ettabetta. "Perhaps we can send a flying note. Or we can get a plane to make letters in the..."

Hot Rod said he didn't think so. "Let's just tape another note to the hide-out," he said.

"O.K.," said Ettabetta. "But it has to be in code."

The note said:

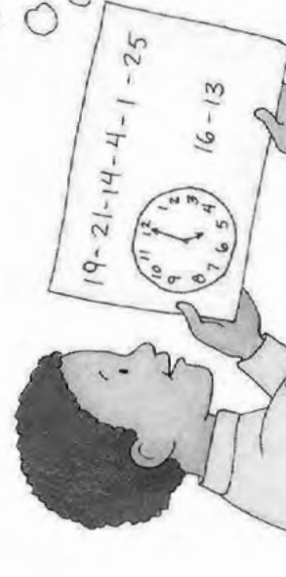
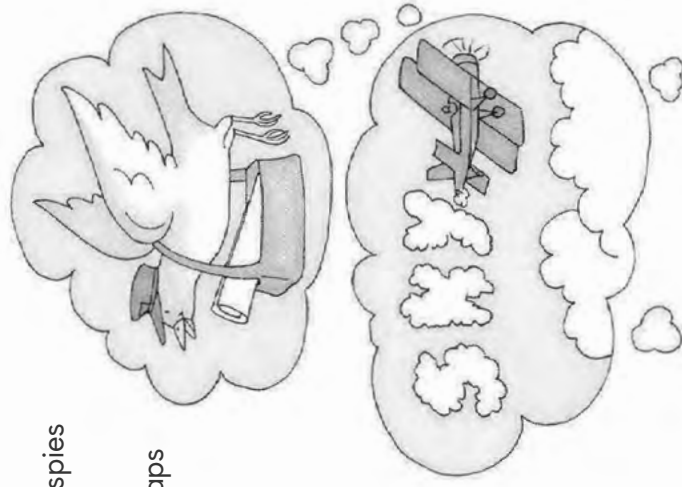

On Sunday Hot Rod and Ettabetta sat inside the hide-out. "Let's put on masks and long capes," said Ettabetta. "Let's dress in black. We can hide under the blanket and jump out on the spies!"

Hot Rod said he didn't think so.

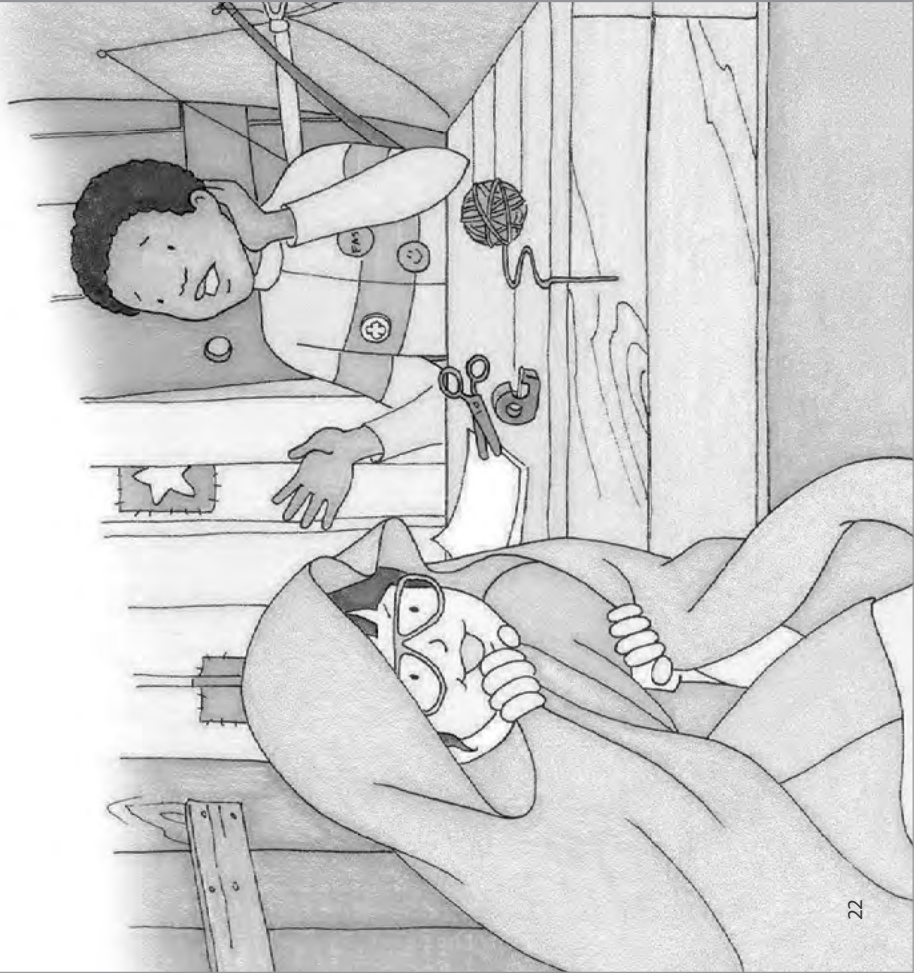

Hot Rod and Ettabetta waited and waited. It felt as if it would never get to be five o'clock.

"Spies are not supposed to be late," said Ettabetta.

"Shhh!" said Hot Rod.

Just then, a branch cracked. "The spies are here!" Ettabetta whispered.

"Hello?" said Hot Rod.

"Enter, spies!" said Ettabetta.

Who came in?



Gerti!

“Are you the gang of spies?” Ettabetta asked.

“Yes!” said Gert. “I made this hide-out when I was a kid. I was glad when you discovered it.”

“How could you tell we discovered it?” asked Hot Rod.

“You smelled like rotten frogs!” said Gert.

“But why didn’t you tell us?” asked Hot Rod. “Why did you pretend to be a gang of spies?”

“Well!” said Gert. “What good is a hide-out if there are no spies?”

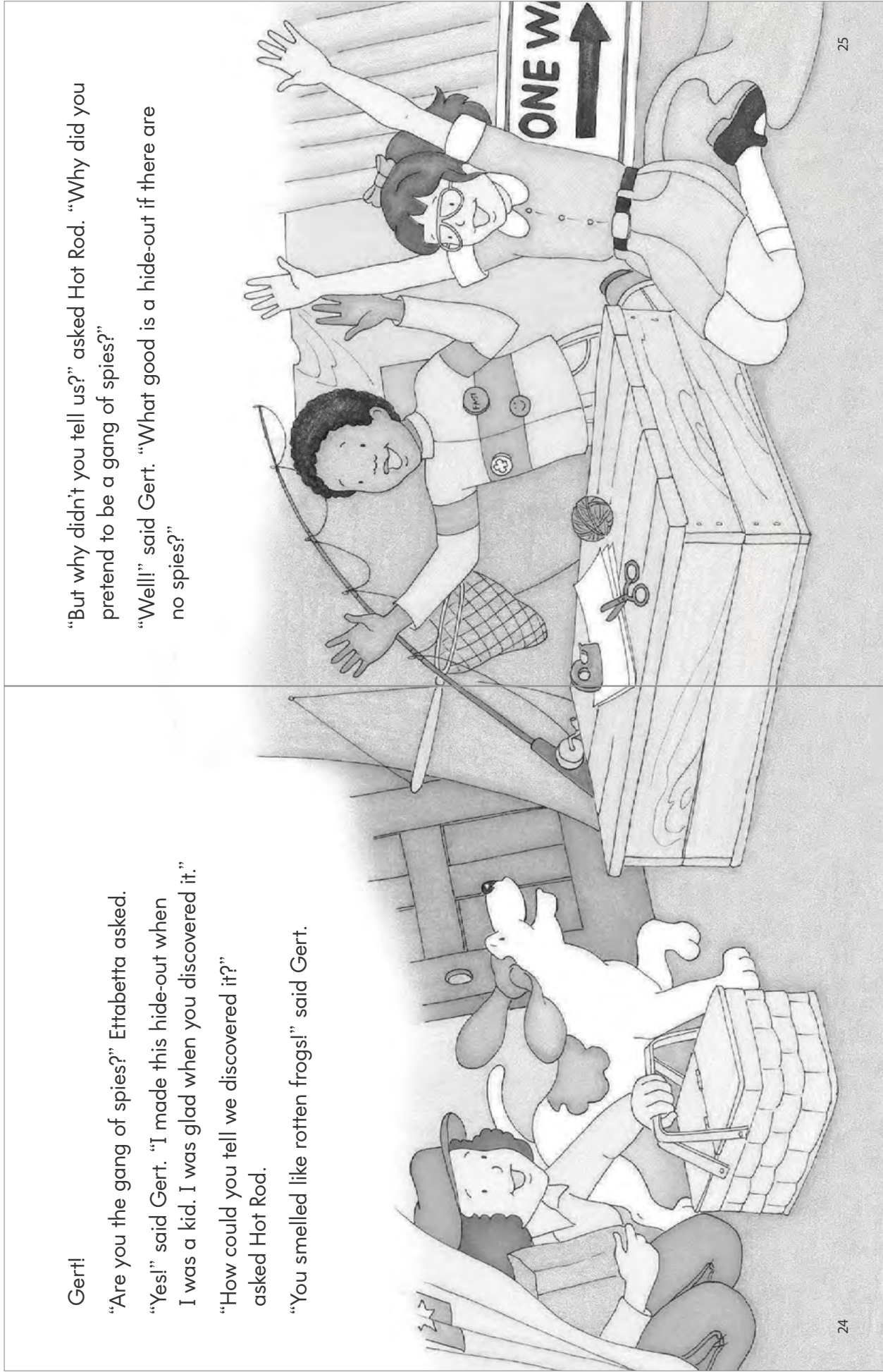

Gert had a big picnic basket. It had sandwiches, milk, and apples in it. Gert also had a lamp, a clock, and a cracked telescope for the hide-out.

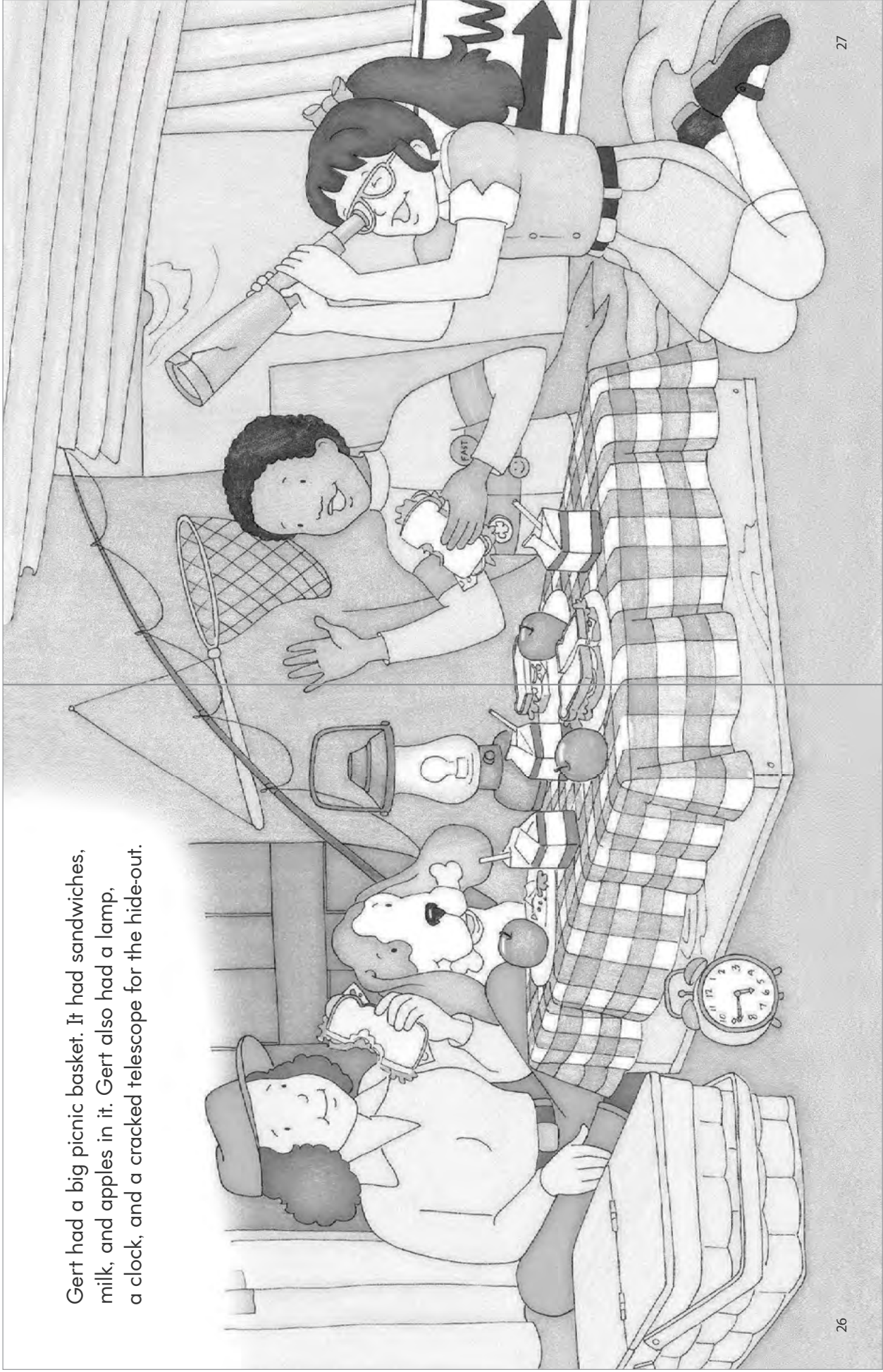

Ettabetta asked, "Gert, do you want to be a member of the hide-out gang?"

"No, thank you," said Gert. "I had my time here. It is time for a new boy and girl to use this hide-out. You two seem to have fixed it up very well."

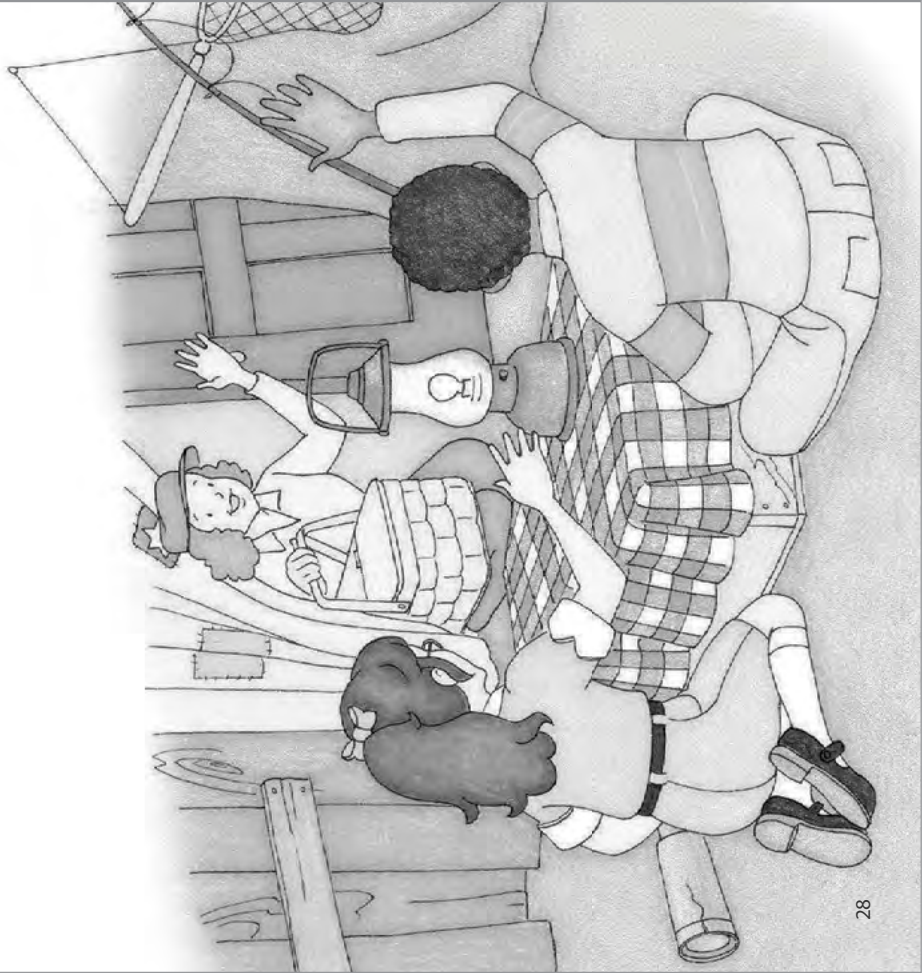

The hide-out belongs to Ettabetta and Hot Rod now. But Gert still visits from time to time. Hot Rod and Ettabetta still get gifts and notes in code. Hot Rod likes to read them.



But Ettabetta is still on the lookout for spies, or perhaps an enchanted green frog, or a monster who will creep out of the pond, or a person from another planet, or who can tell what?

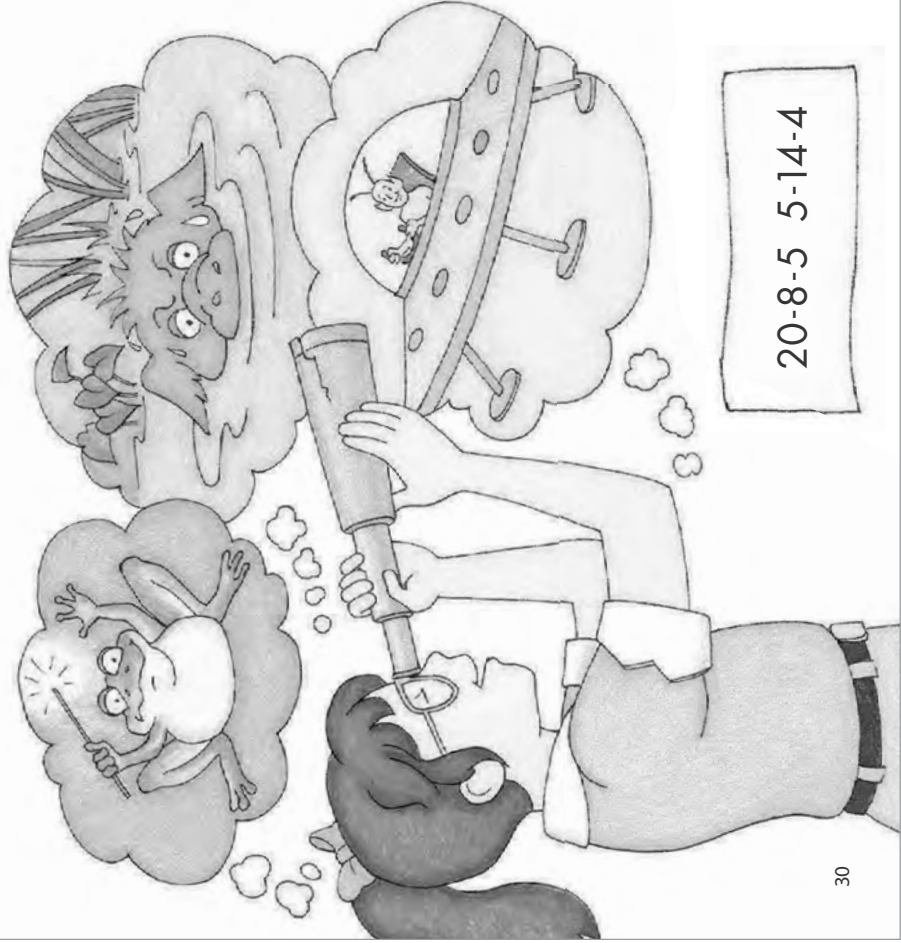

20-8-5 5-14-4

The End

